



M3 Camera System – Installation & User Manual V1.0.1

Contents

3	Remarks
3	Introduction
3	The Process Explained
3	What's Included.
4	Antennas
6	Installation & Technical Information
6	X2 - Transmitter
7	B5 - Battery
8	S5 - Sensor
9	M3 - All in One Monitor
10	R4.1 - Repeater (Optional)
11	CS1 – Charging Station
12	Battery Charging Instructions
12	Operating Instructions
13	Accessing & Downloading Saved data
13	Connecting to the Network
14	Set up the Video Management Software
17	Selecting the Storage Location
18	Viewing and Downloading the Recordings
20	Logging Out & Disconnecting the Laptop
20	Logging In
21	Office Link (Accessory)
22	Axis Companion

Remarks

1. Always adhere to the machine manufacturer's instructions.
2. BlokCam ® should be used to assist the operator's judgement, not replace it.
3. All aspects of installation, removal, charging, use and fault finding should only be carried out by trained and competent persons.
4. Ensure BlokCam ® parts and components do not interfere with machine manufacturers and/or third-party components, parts and systems, moving or otherwise.
5. Prior to adverse weather conditions or in any situation where BlokCam parts or components may become dislodged or come into unfavourable contact with the machine and/or third-party components, moving or otherwise, all magnetically mounted BlokCam parts and components must be removed.
6. Always ensure that Lanyards are connected, and Rapid Links are tightened. Consider that the machine and/or mounting point may change configuration, shape, and size.
7. High powered magnets in use. Neodymium magnets are permanent and strong, use correct protective equipment to avoid trapping hazard.
8. If possible, installation work should be completed at ground level to avoid working at height. For working at height, please refer to regional and site-specific regulations and guidelines and ensure installation team are competent and adequately trained.
9. In Wi-Fi networking, a point-to-point wireless bridge lets users wirelessly connect two or more locations together. This bridge connects two or more locations to share data across the network.
10. BlokCam ® transceivers operate within the 5GHz band. For best results ensure a direct line of sight between paired wireless transceivers and antennas.
11. Frequency selection and transmit power may vary. Please refer to regional regulations, guidelines, and authorities to ensure legal operation.
12. A competent person should carry out pre-use checks prior to the commencement of work. Pre-use check sheets are available online from www.blokc corp.com
13. Parts and components may differ from renders.
14. Manual subject to change without notice
15. Subject to Copyright

Introduction

BlokCam ® is a wireless camera system that can be quickly and easily deployed to a ferrous surface, including steel. The sound and view captured by the camera is then transmitted and received wirelessly to a viewing platform such as a Laptop, tablet, or monitor. This allows the operator to see and hear the load and surroundings, giving an unobstructed, live, audio-visual feed of the previously unseen critical areas.

The Process Explained

1. A Battery provides power to the Transmitter and the Sensors.
2. The Sensors capture, encode, and push the data through the transmitter to the next wireless transceiver.
3. Depending on the required configuration, the data may be transmitted through one or more battery powered transceivers.
4. Finally, the data will reach the transceiver and decoder within the M3 display which projects the image and audio through the Monitor.



What's Included

Qty	Description
4	6mm Rapid Links.
2	90 Degree N-Type Connector.
1	Ram Mount Arm - Double Socket Arm - 4.5 inch.
2	7 dBi Duck Bill Antenna.
1	USB Memory Stick - 2GB.
1	3mm x 600mm Lanyard - Stainless.
1	Triple Suction Cup c/w Monitor Mount Stickers.
3	Stainless Lanyard c/w Retaining Magnet.
1	M3 Camera System Case.
1	PC2 - Power Cable - Battery to Transceiver.
2	PSC1 - Power Supply Cable (DC-DC).
1	PSU1 - Power Supply Unit (AC-DC).
1	AN1 - 14dBi Flat Panel Antenna Assembly
2	B5 - Battery Pack
1	CS1 - Charging Station
1	M3 - All in One Monitor
1	S4 - Sensor
1	X2 - Transmitter
1	Power Lead – (Regional - C13 Kettle)

Antennas

Foreword

A Flat Panel Antenna is an antenna which radiates or receives greater power in specific directions allowing increased performance and reduced interference from unwanted sources.

In general, Flat Panel Antennas provide increased performance over omnidirectional antennas when greater concentration of radiation in a certain direction is desired.

Duck Bill Antennas are omni directional. Omnidirectional antennas are a class of antenna which radiates equal radio power in all directions perpendicular to an axis. This radiation pattern is often described as doughnut shaped. Omni directional antennas do not emit a signal out of the tip of the antenna.

For best performance, the orientation between the transmitting and receiving antennas must remain parallel and in-line (not offset), consistent and with a direct line of sight.

Antenna Relationships

Flat Panel Antenna to Flat Panel Antenna

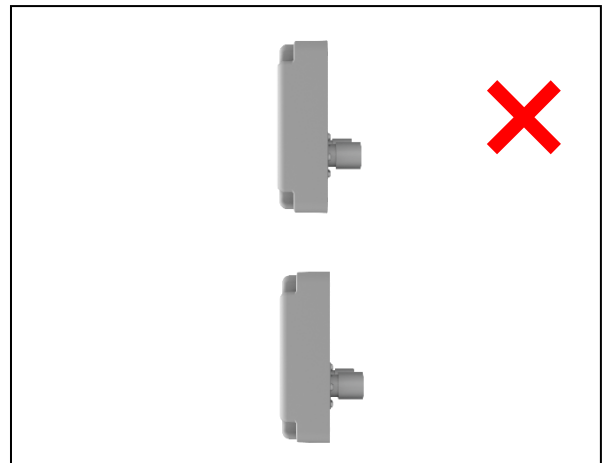
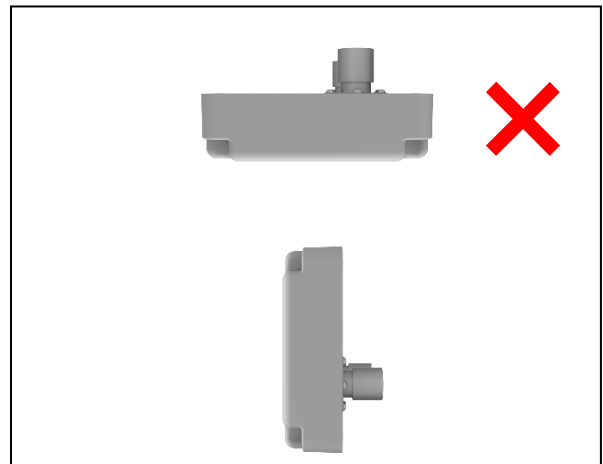
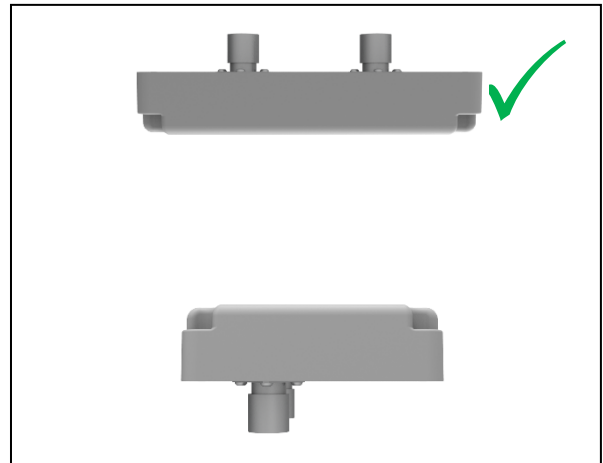
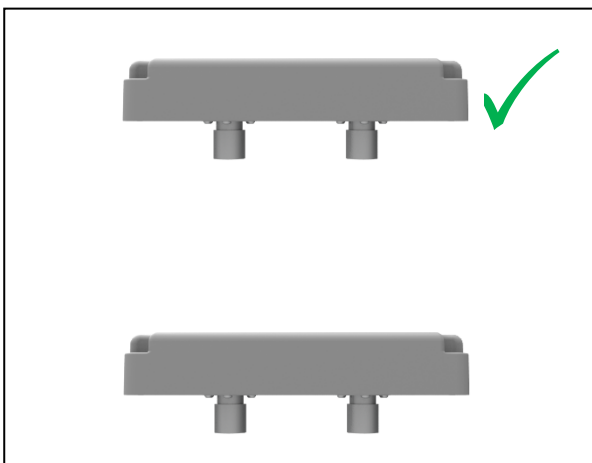
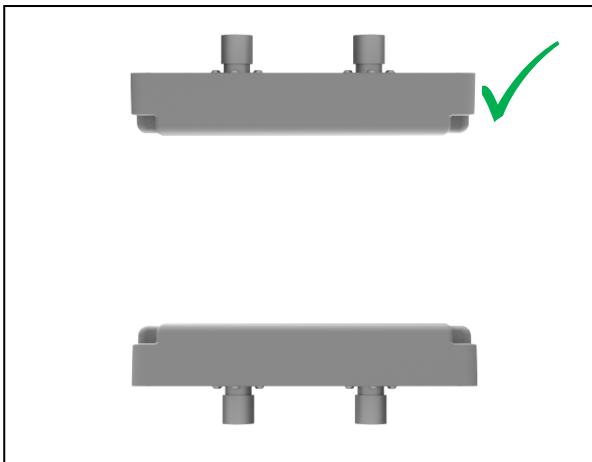

Duck Bill Antenna to Duck Bill Antenna

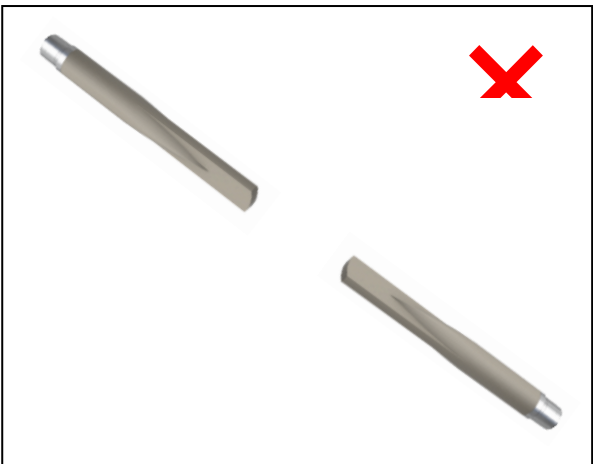
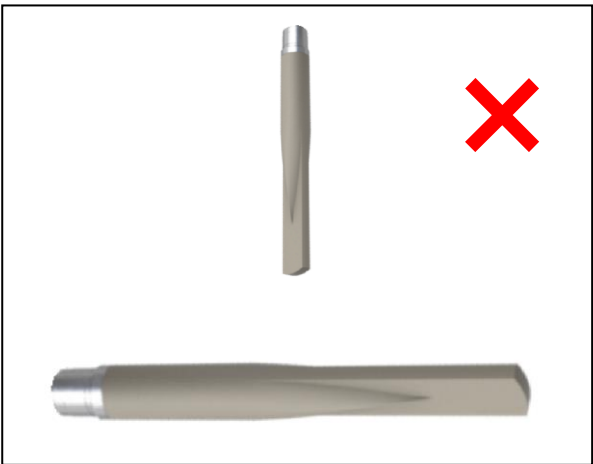
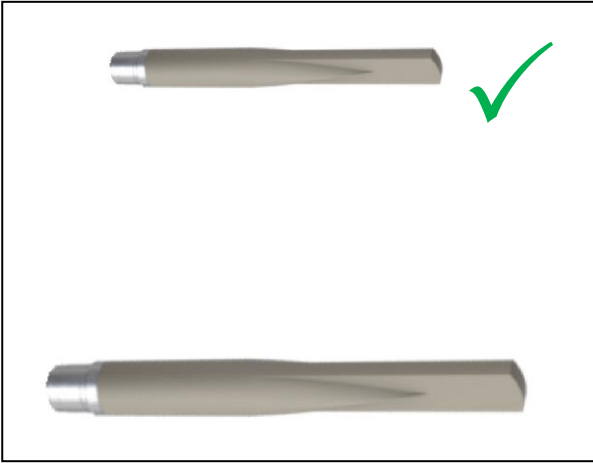

Flat Panel Antenna to Duck Bill Antenna

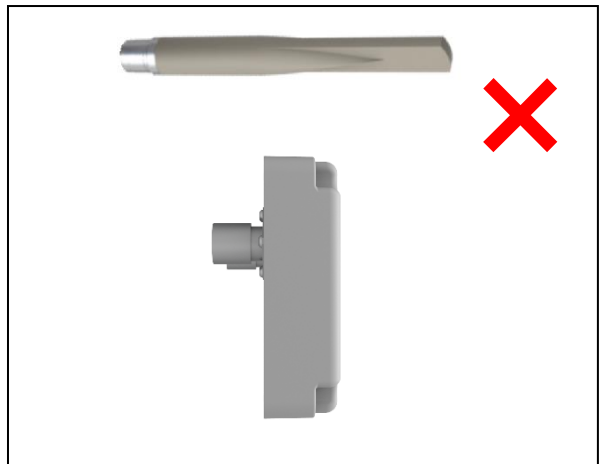
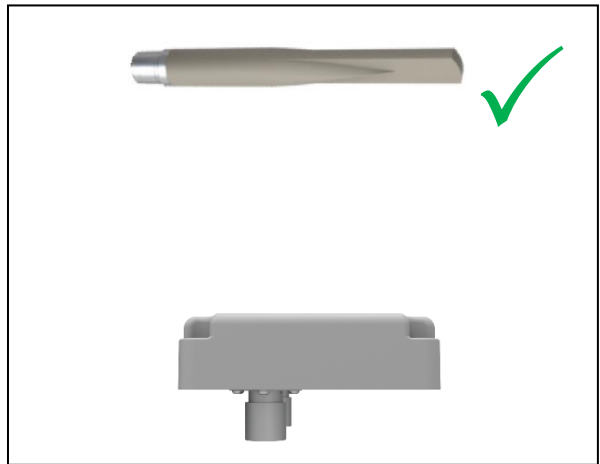
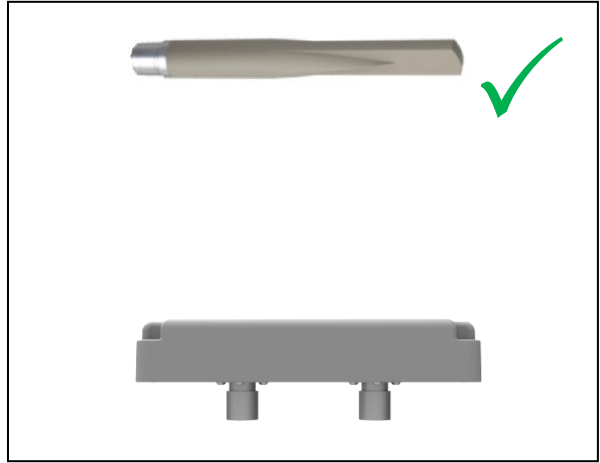

Installation & Technical Information

Foreword

The Transmitter, Sensor/s and Battery connect with cables. Prior to installation, plan a compatible layout and consider:

- a. the intended position of the Sensor
- b. the view from the intended Sensor position;
- c. the Sensor cable length and route;
- d. the lanyard length and distance to a secure point;
- e. the orientation of the Sensor;
- f. the distance to the Transmitter;
- g. the intended position of the Transmitter;
- h. lanyard length and distance to a secure point;
- i. the position and/or intended position of other paired transceivers;
- j. the most suitable antenna for the operation;
- k. the intended position of the Battery;
- l. the power cable length and route;
- m. the distance between the Battery and Transmitter;
- n. the lanyard length and distance to a secure point;
- o. that the battery is changed on a regular basis.

X2 – Transmitter

Shown with duck bill Antennas fitted.

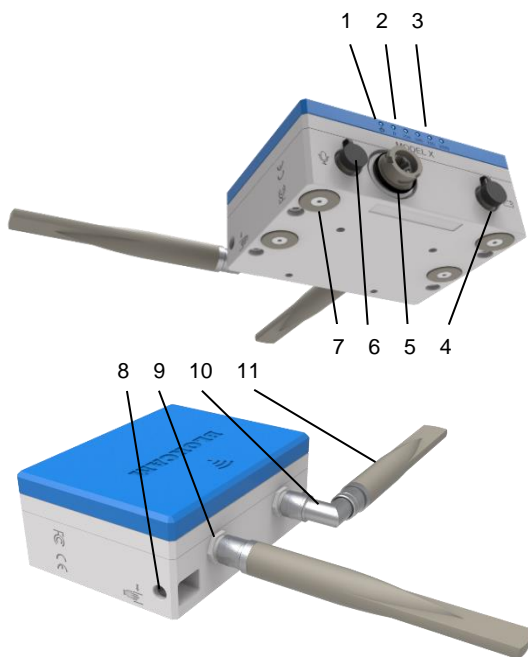

- 1. LED - Power
- 2. LED - Data
- 3. LED's - Signal Strength 25% - 100%
- 4. Input Socket - 12-24Vdc
- 5. Sensor Socket - Video
- 6. Sensor Socket – Audio
- 7. Mounting Magnets (x4)
- 8. Rapid Link Anchor Points (x2)
- 9. Antenna Ports (x2)
- 10. 90 Degree N-Type Connector
- 11. 7dBi Duck Bill Antennas (x2)

Technical Specifications

Video compression: H.264 (MPEG-4 Part 10/AVC) Baseline, Main and High Profiles Motion JPEG

Resolution: 1920x1200/1080

Frame Rate: 25/30 fps (50/60 Hz)

Video streaming: Multiple, individually configurable streams in H.264 and Motion JPEG

Image settings: Compression, colour, brightness, sharpness, contrast, white balance, exposure value, exposure control, exposure zones, local contrast, rotation, Corridor Format, text and image overlay, privacy mask, mirroring of images

Audio streaming: One-way

Audio input: External microphone input

Transmission Frequency: 5 GHz

Transmit Power: 19-25dBm

Size and Weight:

Height: 128mm (5.04 inches)

Width: 170mm (6.69 inches)

Depth: 71mm (2.8 inches)

Weight: 2100g (4.63 pounds)

Casing: Aluminium.

Power: 12-24Vdc

Power Consumption: Max 13.3 W

Antenna Connector: N-Type

Storage: Two internal SD/SDHC/SDXC slot supporting memory card, 2 x 64Gb card included.

Operating Conditions: -20 °C to 60 °C (-4 °F to 140 °F)

Humidity 10-85% RH (non-condensing)

Storage Conditions: -40 °C to 65 °C (-40 °F to 149 °F)

IP Rating: IP 67 (with external ports connected)

Mount & Secure the Transmitter/s

- 1. Magnetically mount the Transmitter to a clean and flat surface.
- 2. Choose the most suitable antenna/s based on the location of other transceivers.
- 3. Connect the antenna/s to the antenna ports. On the top side of the Transmitter
- 4. If required, use the N-type right angle connectors (elbow joints) to achieve the desired position.
- 5. Once the optimum position has been achieved, firmly tighten the fittings.
- 6. Fit Rapid Link to Transmitter anchor point.
- 7. Choke and secure a lanyard to a fixed and secure point.
- 8. Attach the loose end of Lanyard to the Rapid Link.
- 9. Firmly tighten the Rapid Link.

When necessary reverse the above steps for removal.

B5 - Battery

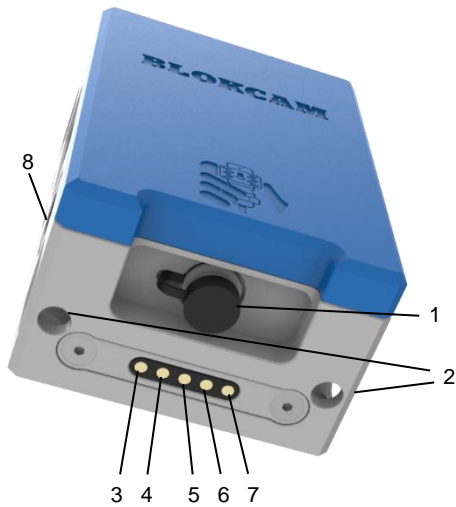

1. Output Socket (Pin 1 - Negative, Pin 2 - Positive)
2. Rapid Link Anchor Points x 4 (x2 on top face, not shown)
3. Recharge Docking Contact - Pin 1 (-) Negative
4. Recharge Docking Contact - Pin 2 (+) Positive
5. Recharge Docking Contact - Pin 3 (+) Thermistor
6. Recharge Docking Contact - Pin 4 (+) Charge station loop
7. Recharge Docking Contact - Pin 5 (+) Charge station loop
8. External Fuse Holder
9. Mounting Magnets x3 (on rear, not shown)

Technical Specifications

Capacity: 19.2V 4.2Ah

Cell Manufacturer: Panasonic

Cell Type: Nickel-Metal Hydride Battery

Nominal Cell Voltage: 1.2V

Easy Access Fuse: 500mA

Size and Weight:

Height: 155mm (6.11 inches)

Width: 105mm (4.1 inches)

Depth: 71mm (2.8 inches)

Weight: 2400g (5.29 pounds)

MSDS: available from www.blokcorp.com

IP Rating: IP 67 (with external ports connected)

Mount, Connect & Secure the Battery

1. Magnetically mount the Battery to a clean and flat surface.
2. Connect the Power Cable between the Output socket on the Battery and the Input Socket  on the Transceiver.
3. Secure the cable to a clean and flat surface using the pre-installed cable magnets.
4. Fit Rapid Link to Battery.
5. Choke and secure a lanyard to fixed and secure point.
6. Attach the loose end of lanyard to the Rapid Link.
7. Firmly tighten the Rapid Link.

When necessary reverse the above steps for removal.

S4 - Sensor

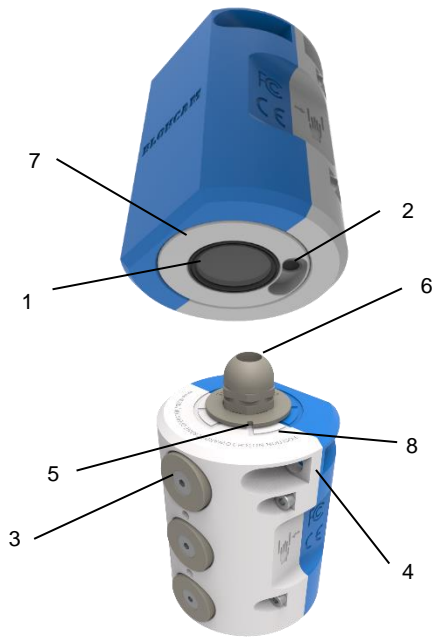

1. Video Sensor
2. Audio Sensor
3. Mounting Magnets
4. Rapid Link Anchor Points (x2)
5. Notch - Orientation Indicator Plate
6. Cable Gland
7. Sprung Loaded Rotary Boss
8. Map - Orientation Guide
9. Plug - Video Sensor (not shown)
10. Plug - Audio Sensor (not shown)

Technical Specifications

Video Sensor: Fixed Iris, 1080p

Resolutions: Max1920x1200/1080

Minimum illumination: Colour: 0.3 lux

Frame Rate: Max 50/60 fps (50/60 Hz)

Audio streaming: One-way

Audio input: External microphone input

Transmission Frequency: 5 GHz

Transmit Power: 19-25dBm

Size and Weight:

Height: 100mm (3.94 inches)

Width: 75mm (2.95 inches)

Depth: 69mm (2.72 inches)

Weight: 1250g (2.76 pounds)

Casing: Aluminium.

Power: Provided by Transmitter

Operating Conditions: -20 °C to 55 °C (-4 °F to 131 °F)

Humidity up to 75% RH (non-condensing)

Storage Conditions: -20 °C to 60 °C (-4 °F to 140 °F)

IP Rating: IP 67 (with external ports connected, excludes IP65 Audio Sensor)

Mount, Connect & Secure the Sensor/s

Foreword

The installation and orientation of the Sensor should correctly correlate with the monitor and machinery movements. Following installation, test to ensure the relationship between the Sensor, monitor and machinery are fixed, permanent and accurate i.e. is the image the correct orientation, all the time?

Note: When mounting a Sensor to a rotating surface, the added variable may cause a lack of synchronicity between the Sensor, monitor and machinery.

1. Changing the orientation of the camera is a tool free operation. The Camera and Rotary Boss are sprung loaded into locator slots. To rotate the camera, lift, rotate and lower the Sprung Loaded Rotary Boss. Use the engraved text, map, and notch as a guide to relocate correctly. As indicated the Rotary Boss will not rotate past 315 degrees due to the rotation stop.

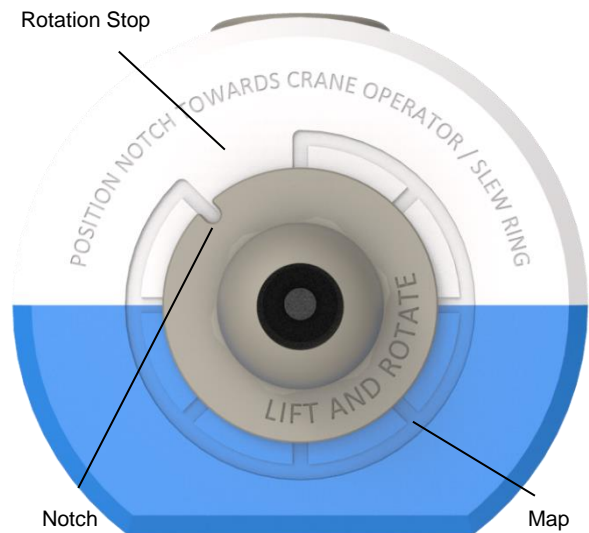



2. Magnetically mount the Sensor to a clean and flat surface.
3. Connect the Sensor Plug to the Sensor Socket on the underside of the Transmitter.
4. Connect the Audio Plug to the Audio Socket on the underside of the Transmitter.
5. Secure the cable to a clean and flat surface using the pre-installed cable magnets.
6. Fit Rapid Link to Sensor anchor point.
7. Choke and secure a lanyard to a fixed and secure point.
8. Attach the loose end of lanyard to the Rapid Link.
9. Firmly tighten the Rapid Link.

When necessary reverse the above steps for removal.

M3 – All in One Monitor

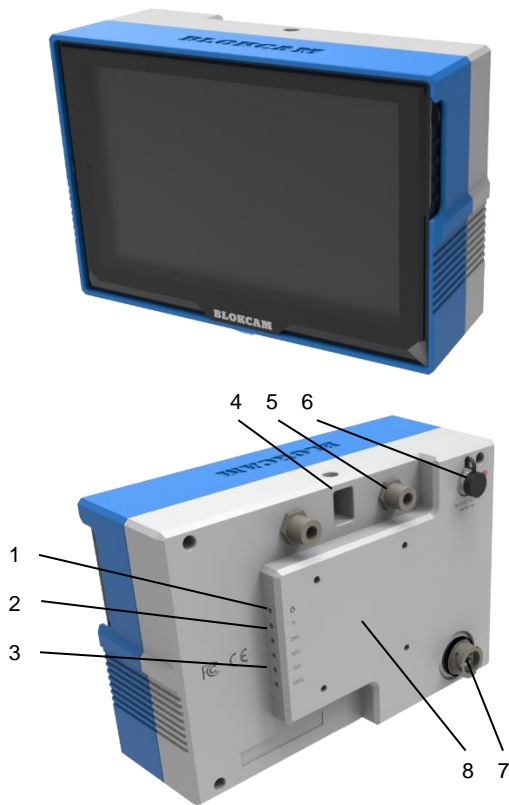
Shown without Antennas and Ball Joint Vesa Mount fitted



1. LED – Power
2. LED - Data
3. LED's - Signal Strength 25% - 100%
4. Rapid Link Anchor Points (x1)
5. Antenna Ports (x2)
6. Input Socket - 9-30Vdc 
7. Cat5e LAN Port
8. Vesa Mount complete with ball joint and triple suction cup mount (not shown)
9. Flay Panel Antenna (not shown)

Technical Specifications

Transmission Frequency: 5 GHz

Transmit Power: 19 to 25dBm

Receiver Sensitivity: -90 to -75 dBm

Size and Weight:

Height: 180mm (7.09 inches)

Width: 265mm (10.43 inches)

Depth: 115mm (4.5 inches)

Weight: 3300g (7.28 pounds)

Casing: Aluminium.

Power: 9-30Vdc

Power Consumption: Max 16.5 W

Antenna Connector: N-Type

Operating Conditions: -20 °C to 70 °C (-4 °F to 158 °F)

Humidity up to 5 to 95% (non-condensing)

Storage Conditions: -40 °C to 90 °C (-40 °F to 194 °F)

Humidity Max 90% (non-condensing)

Mount, Connect & Secure the M3 Monitor

Foreword

A flat panel antenna and mounting bracket are preinstalled to the rear of the M3 Monitor. Prior to installation consider:

- a. the intended position of the Sensor
 - b. the operators view;
 - c. the power supply cable length and route;
 - d. the lanyard length and distance to a secure point;
 - e. the position and/or intended position of other paired transceivers;
1. With the Triple Suction Cup, attach the monitor to suitable, clean, flat, smooth, non-porous surface (typically, the side window of crane cab).
 2. Adjust the mounting system to achieve the desired position and firmly tighten the Ram Mount Brackets.
 3. Connect the Power Supply Cable between the Input socket on the rear of the M3 display and a suitable power supply.
 4. Fit Rapid Link to Anchor Point.
 5. Choke and secure a lanyard to fixed and secure point.
 6. Attach the loose end of lanyard to the Rapid Link.
 7. Firmly tighten the Rapid Link.

When necessary reverse the above steps for removal.

R4.1 – Repeater (Optional)

Shown without Antennas fitted

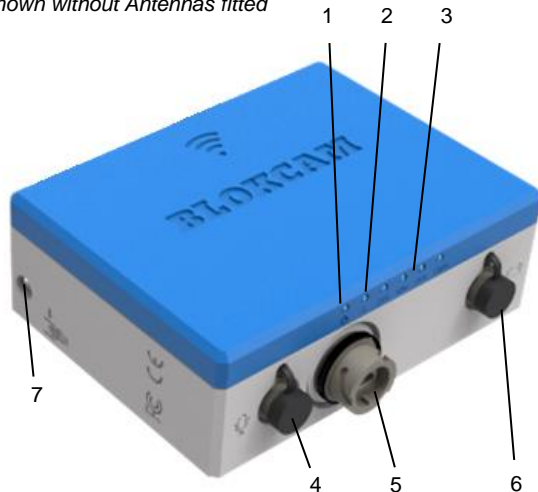

1. LED - Power
2. LED - Data
3. LED's – Signal Strength 25% - 100%
4. Socket - Blank
5. Socket - PoE LAN Port
6. Input Socket – 12-24Vdc \square +
7. Rapid Link Anchor Points (x2)
8. Antenna Ports x2 (on top, not shown)
9. Mounting Magnets x 4 (on rear, not shown)

Technical Specifications

Transmission Frequency: 5 GHz

Transmit Power: 19 to 25dBm

Receiver Sensitivity: -90 to -75 dBm

Size and Weight:

Height: 128mm (5.04 inches)

Width: 170mm (6.69 inches)

Depth: 58mm (2.28 inches)

Weight: 1800g (3.97 pounds)

Casing: Aluminium.

Power: 12-24Vdc, Passive PoE 24V

Power Consumption: Max 5.5 W

Antenna Connector: N-Type

Operating Conditions: -20 °C to 70 °C (-4 °F to 158 °F)

Humidity up to 5 to 95% (non-condensing)

Storage Conditions: -40 °C to 90 °C (-40 °F to 194 °F)

Humidity Max 90% (non-condensing)

IP Rating: IP 67 (with external ports connected)

Mount & Secure the Repeater/s

Foreword

The Repeater is a modular transceiver that relays the wireless signal. The Repeater can be powered over ethernet (POE), by the BlokCam ® Battery or an alternative 12-24Vdc supply.

To protect against ingress, it is necessary to cap and seal all unused ports using the supplied blanking plug/s.

The installation, quantity, mounting, location, position and orientation are dependent on the required configuration.

Systems with multiple Repeaters must be connected in the correct series order.

The Repeater and Battery connect with cables. Prior to installation, plan a compatible layout and consider:

- a. the intended position of the Repeater;
- b. lanyard length and distance to a secure point;
- c. the position and/or intended position of other paired transceivers;
- d. the most suitable antenna for the operation;
- e. the intended position of the Battery;
- f. the power cable length and route;
- g. the distance between the Battery and Repeater;
- h. the lanyard length and distance to a secure point;
- i. that the battery is changed on a regular basis.

1. Magnetically mount the Repeater to a clean and flat surface.
2. Choose the most suitable antenna/s based on the location of other transceivers.
3. Connect the antenna/s to the antenna ports. On the top side of the Repeater
4. If required, use the N-type right angle connectors (elbow joints) to achieve the desired position.
5. Once the optimum position has been achieved, firmly tighten the fittings.
6. Fit Rapid Link to Repeater anchor point.
7. Choke and secure a lanyard to a fixed and secure point.
8. Attach the loose end of Lanyard to the Rapid Link.
9. Firmly tighten the Rapid Link.
10. Mount, Connect & Secure the Battery as detailed on page 7.

When necessary reverse the above steps for removal.

CS1 - Charging Station

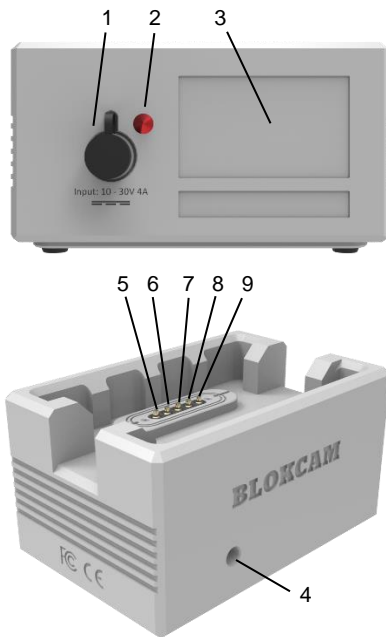

1. Input Socket - 10-30Vdc 4A
2. Input Socket - Colour Code – Red
3. Charge Indicator Plate
4. LED – Charge indicator
5. Recharge Spring Contact - Pin 1 (-) Negative
6. Recharge Spring Contact - Pin 2 (+) Positive
7. Recharge Spring Contact - Pin 3 (+) Thermistor
8. Recharge Spring Contact - Pin 4 (+) Charge station feed
9. Recharge Spring Contact - Pin 5 (+) Charge station return

Technical Specifications

Power: 10-30Vdc 4A

Size and Weight:

Height: 85mm (3.35 inches)

Width: 150mm (5.9 inches)

Depth: 100mm (3.94 inches)

Weight: 1650g (3.64 pounds)

Casing: Aluminium.

Internal Fuse: 5A

Charge Indicator Plate

Led	Mode	Output
Yellow	No battery	41v
Yellow	Initialization	50mA
Orange	Fast Charge	0.9A
Green/yellow	Top-off ch	130mA
Green	Trickle ch	50mA
Orange/Green	Error	50mA

Connecting the Charging Station

Foreword

The charging station should be kept in a clean and dry environment.

1. Place the Charging Station on a clean, dry, flat and level surface. Ensure ease of access and egress and that the chosen position is within reach of a suitable power source.
2.
 - a. Connect the AC-DC Power Supply Unit and associated PSU Mains Lead between the Red Input Socket and a mains supply socket.

or

 - b. Connect the DC-DC Power Supply Cable between the Red Input Socket and a suitable DC supply socket.

When necessary reverse the above steps for removal.

Battery Charging Instructions

Foreword

The BlokCam ® M3 camera system runs on a non-hazardous battery. Under normal operating conditions each battery should provide approximately 12 hours of use. Certain operating conditions will decrease the standard runtime of the battery, including extreme hot or cold temperatures. The battery takes approximately 5 hours to fully charge.

Spare batteries should be kept in a clean and dry environment. BlokCam ® recommend swapping and charging the battery at the beginning of every shift.

1. Ensure charging contacts on the Battery and Charging Station are clean, dry and in good condition.
2. Ensure that the Charging Station is powered up.
3. Place the discharged battery into the Charging Station.



4. Use the Charge Indicator LED and Indicator Plate to monitor the charge condition.
5. When charged and/or required, lift the battery from the Charging Station.

Operating Instructions

Foreword

Operation is reliant on correct installation, charged batteries and/or a reliable power source.

1. Power up the M3 Monitor via the suitable power supply. The Monitor should power up automatically.
2. Power up the all transceivers with a fully charged battery as instructed on page 7.
3. Following completion of the start-up procedure the camera system should be fully functional and ready to use.
4. If required, re-position the sensor to achieve the desired view.

Accessing & Downloading Saved Data

Foreword

To access and download saved data, ensure the BlokCam® system and components are installed correctly and fully operational.

You will need a Laptop with VMS installed (Video Management Software), a Cat5e RJ45 Patch Cable of suitable length, basic networking and IT skills and access to the M3 – All in One Monitor. Laptop/System recommendations and VMS are available from www.blokc.com

Connecting to the Network

1. Connect the Cat5e RJ45 Patch Cable between the laptop and LAN Port on the rear of the M3 – All in One Monitor.
2. To avoid conflict, ensure all other networks, wired or otherwise are disconnected and/or disabled.
3. Ensure the Laptop Internet Protocol Version 4 Properties are configured to 'Obtain an IP address automatically'.
4. Ensure the Laptop Internet Protocol Version 4 Properties are configured to 'Obtain DNS server address automatically'.

In some scenarios it may be necessary to manually configure the Laptops IP Address.

An IPv4 IP Address is made up of 4 Octets. The first, second and third Octet must be identical for connectivity across all paired units. The fourth Octet must be unique to avoid conflicting IP Addresses.

IPv4	1 st Octet	2 nd Octet	3 rd Octet	4 th Octet
Laptop	192	168	0	189
Camera	192	168	0	191
Transmitter	192	168	0	192
1 st Repeater	192	168	0	193
2 nd Repeater	192	168	0	194
Office Link	192	168	0	195

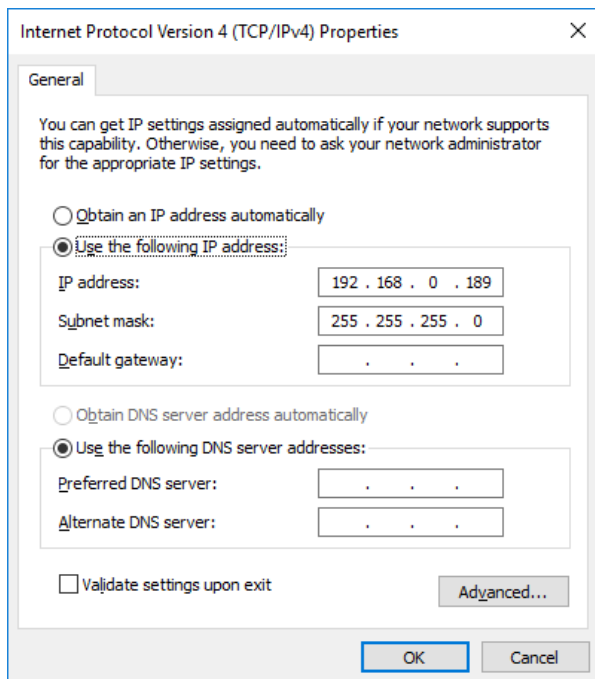

Set up the Video Management Software

1. Open the VMS application.
2. Select 'Create new site' or 'GET STARTED'.

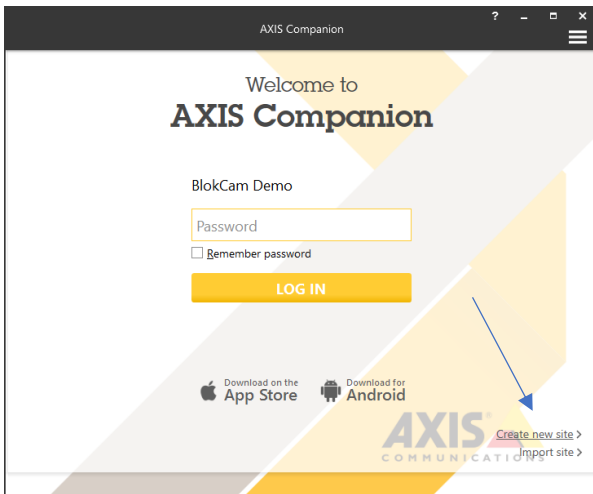

or



3. Choose and type your preferred site name into the 'Site name' box.



4. Obtain the Site password from an authorised BlokCam® dealer. Do not create a password. Creating a password will lead to system failure.

5. Type the procured password into the 'Site password' box.

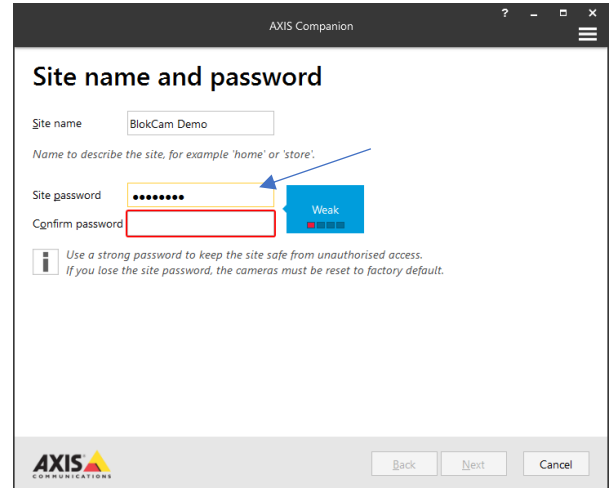

6. Re-type the procured password into the 'Confirm password' box.

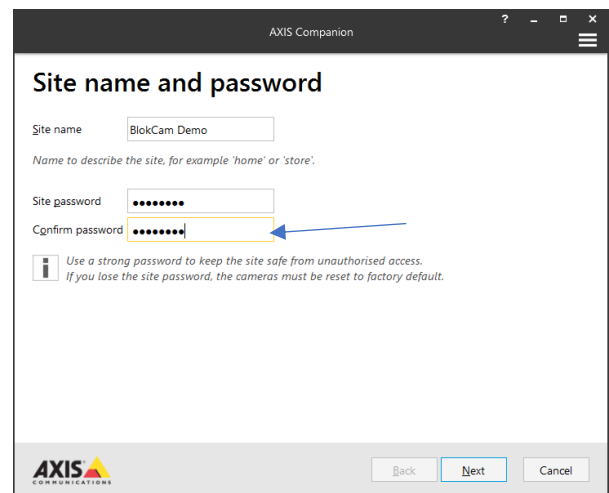

7. Select 'Next'.

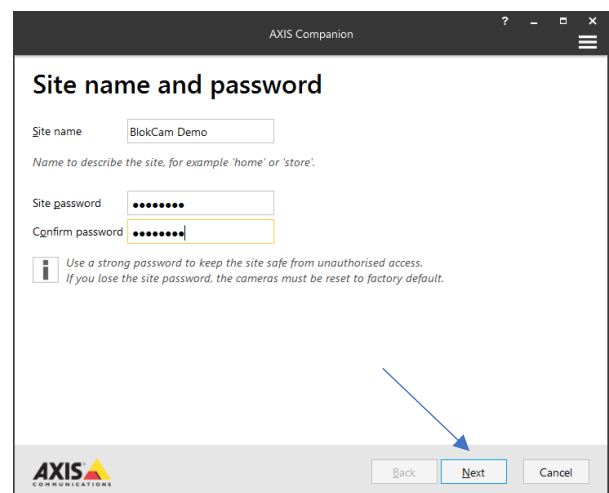

- The VMS will attempt to automatically search and discover all available network cameras. If the desired camera is discovered, skip to step 12.

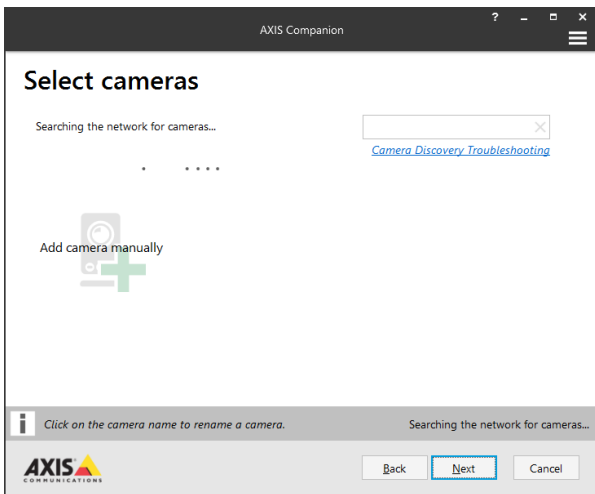

- If the desired camera is not automatically discovered, obtain the cameras IP Address from an authorised BlokCam® dealer and add the camera manually.

- Type the procured IP Address into the 'Enter camera address' box.

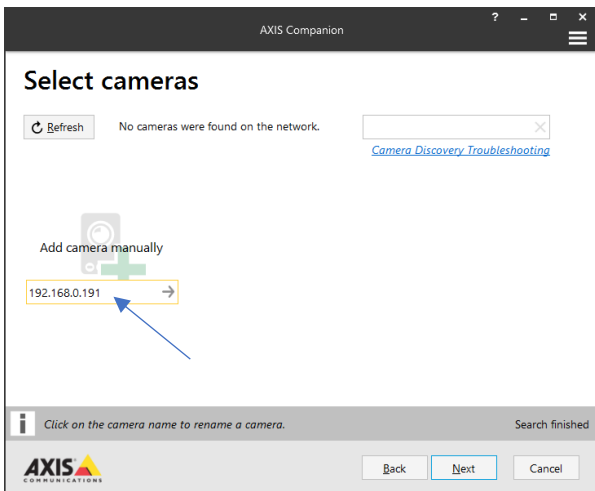

- Select the 'ADD' arrow to the right of the IP Address

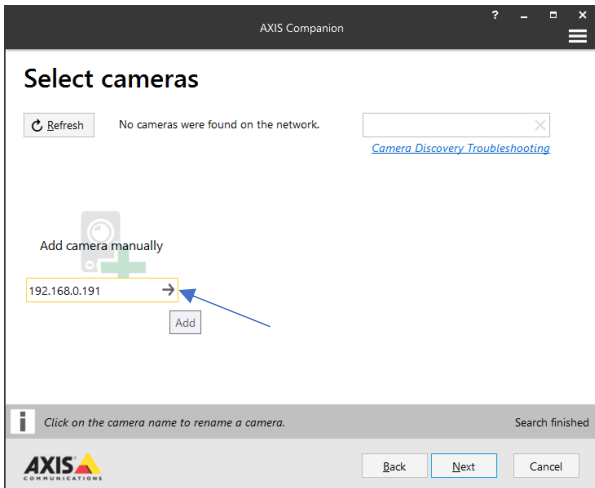

- Ensure the desired camera/s is/are selected.

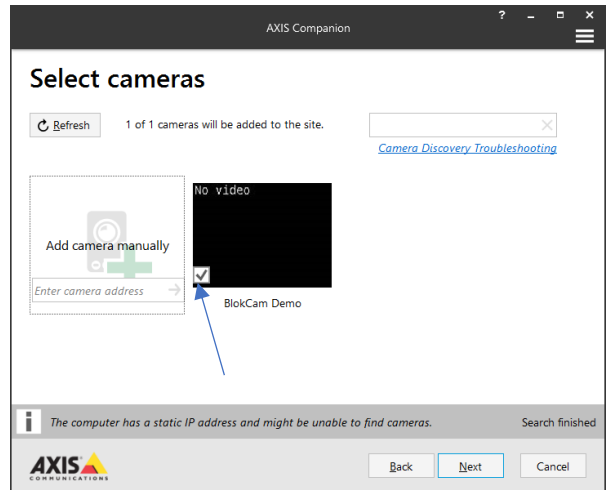

- Select 'Next'.

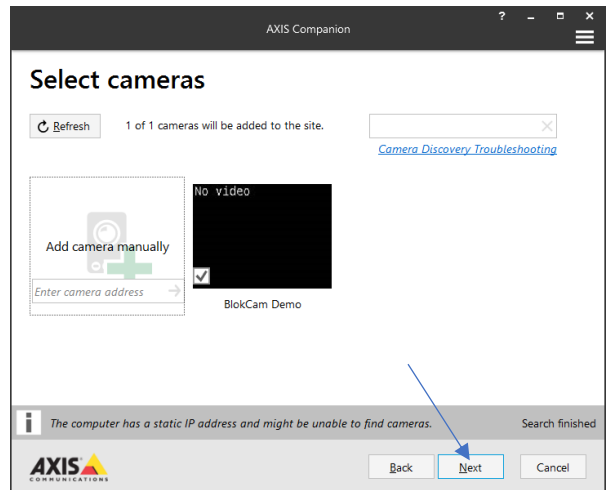

- Wait until the VMS contacts the selected camera/s.

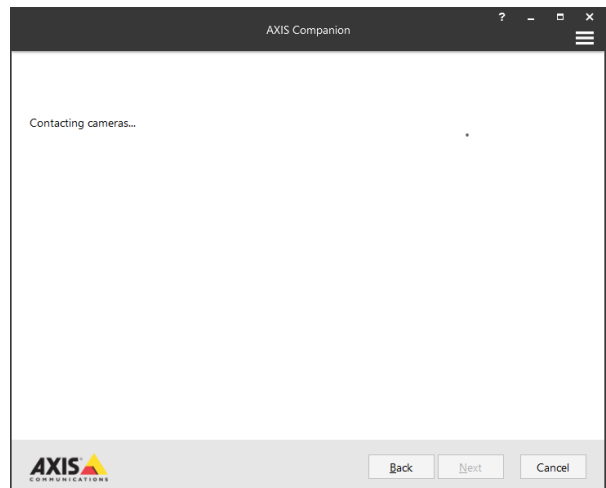

15. Select 'Finish' on the 'Ready to install' page.

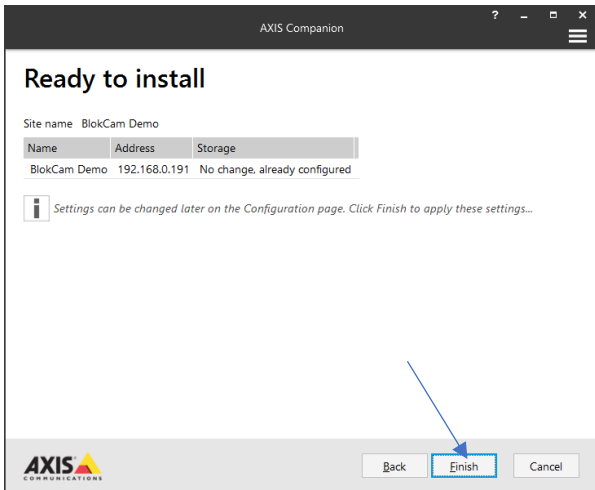

16. Wait until the VMS installs the selected camera/s.

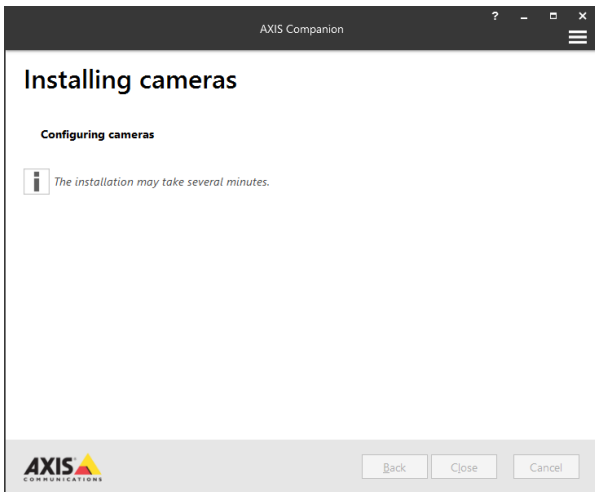

Selecting the Storage Location

1. Locate 3 icons on the top left of the VMS software screen. Select 'Go to Configuration'.

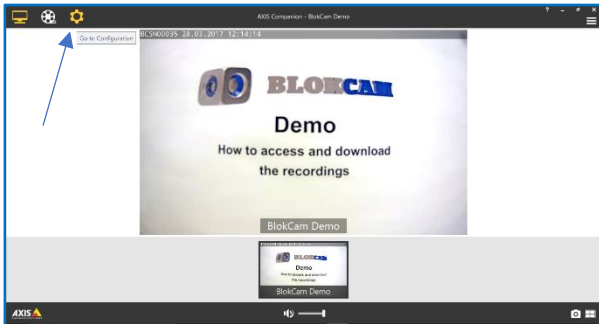

2. Select 'Customize' on the 'Go to Configuration' Screen.

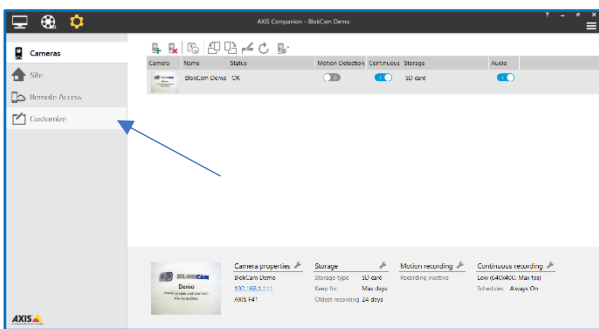

3. Under the heading 'Snapshot folder' locate and select 'Browse...'

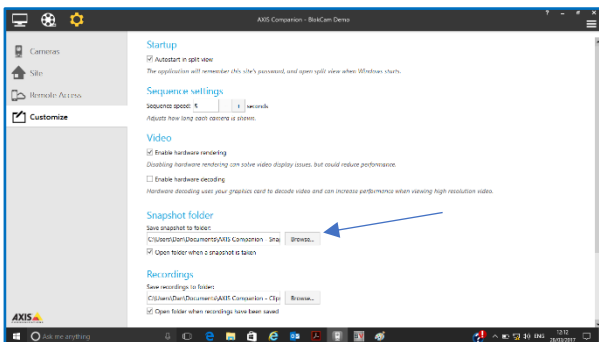

4. Select the desired storage location.

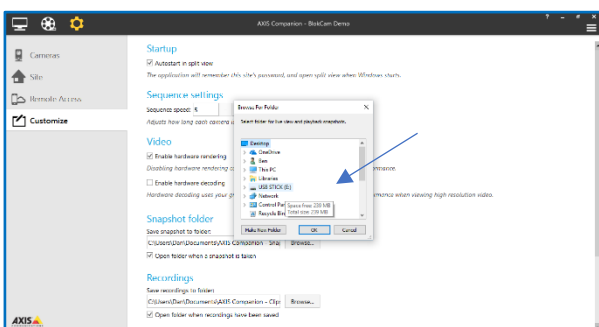

5. Select 'OK'.

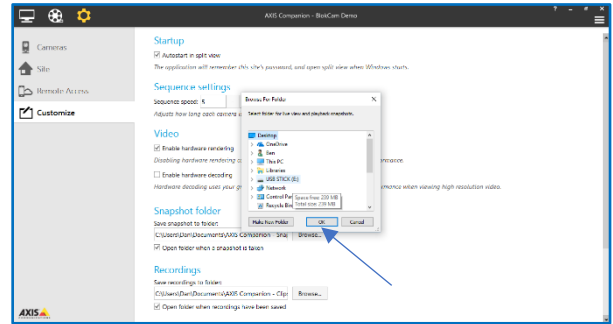

6. Check the storage location has changed and select 'Open folder when snapshot is taken' box.

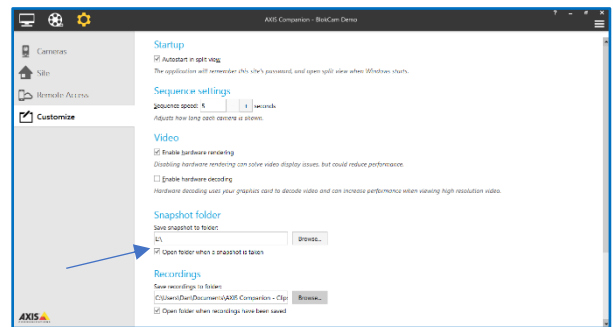

7. Repeat steps 3 – 6 for the 'Recordings' section.

Viewing & Downloading the Recordings

1. Locate the 3 icons on the top left of the VMS software screen. Select 'Go to Recordings'.

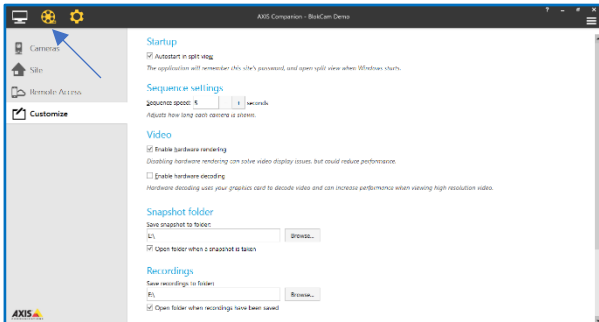

2. Select the footage from the date required by scrolling through the dates using the arrows left and/or right of the date displayed.

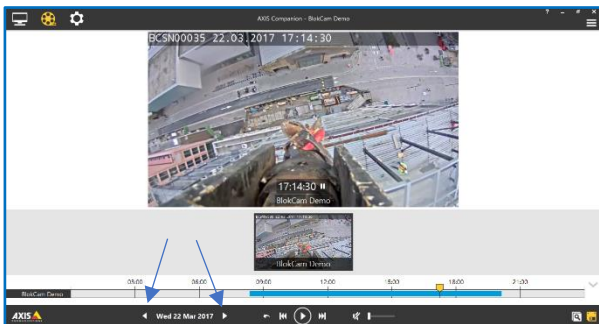

3. Locate and select the 'Save Recordings' icon on the bottom right of the VMS screen.

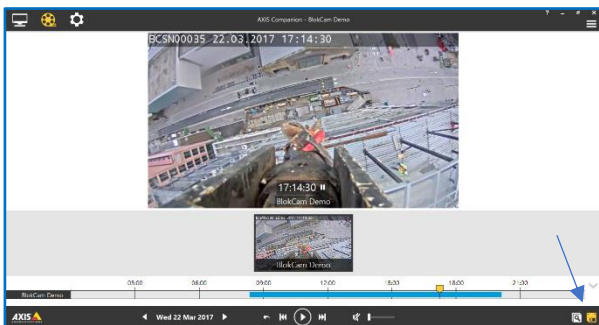

4. The blue timeline indicates the duration of recording on the selected date. Use the grey trimming arrows to reduce or increase the duration of the required interval. For speed and storage reasons, please keep the download duration to a minimum.

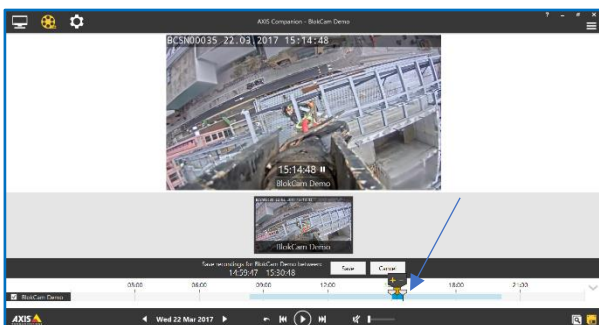

5. If required, select the yellow arrow. Then magnify the timeline using the + and/or - option/s.

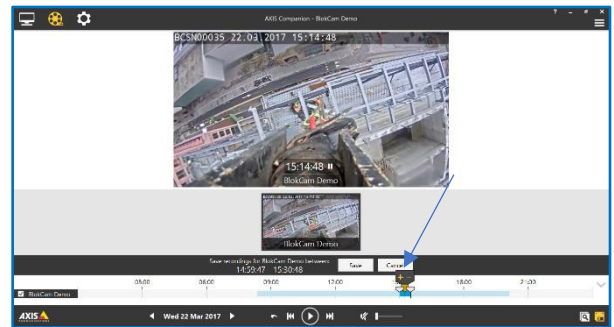

6. If necessary, repeat and refine step 4.

7. When the required interval has been found, select 'Save'.

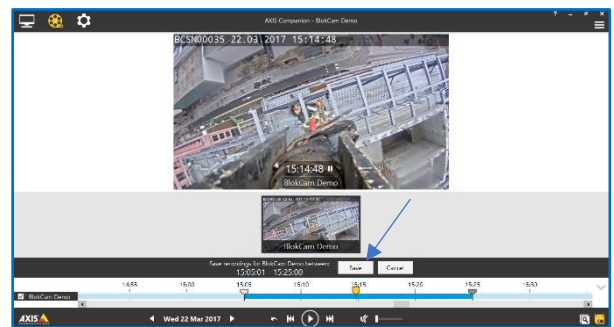

8. Wait whilst the selected recording interval is saved to the desired location.

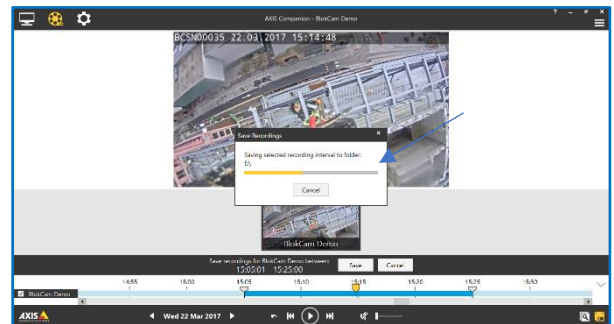

9. When the recording interval is saved, the folder containing the file will open. Check the file is stored in the required location and close the folder using the 'X' at the top right of the 'Folder' page.

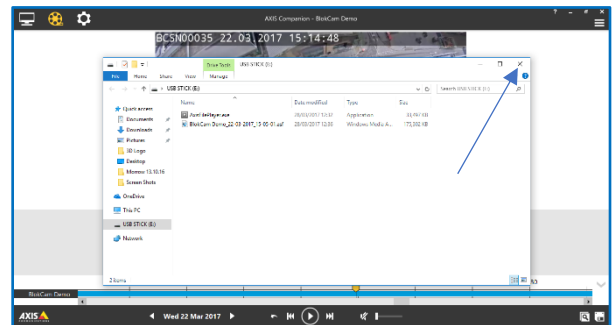

10. Repeat Steps 1 – 9 to extract more recording intervals if required.

Viewing & Downloading the Screenshots

1. Access the 'Go to Recordings' screen. Locate the 3 icons on the top left of the VMS screen. Select 'Go to Recordings'.

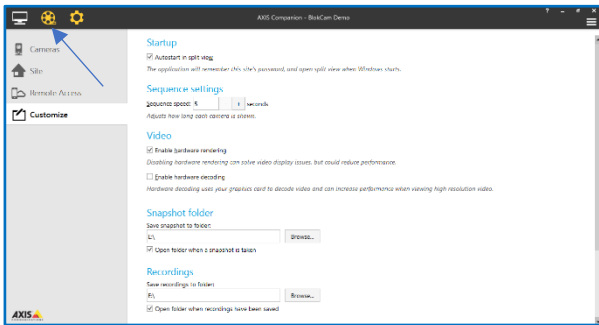

2. Select the footage from the date required by scrolling through the dates using the arrows left and/or right of the date displayed.

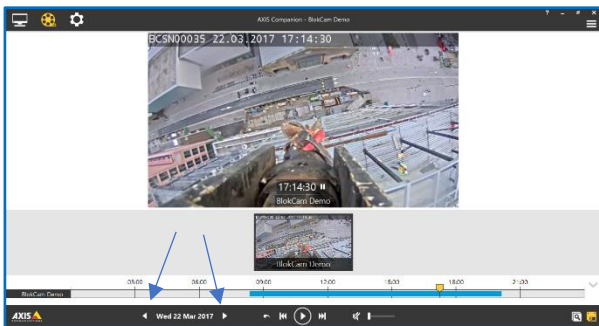

3. Select and slide the yellow arrow to magnify, locate and refine your search.

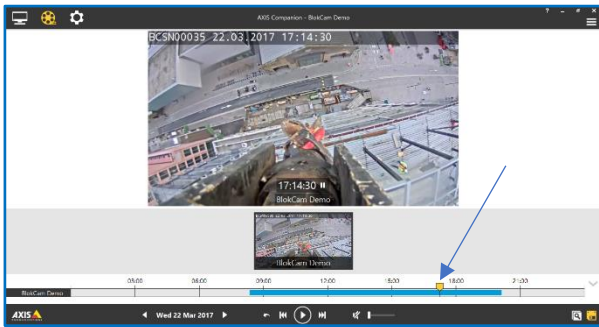

4. Locate the required image and select the 'Investigation Mode' icon on the bottom right of the VMS screen.

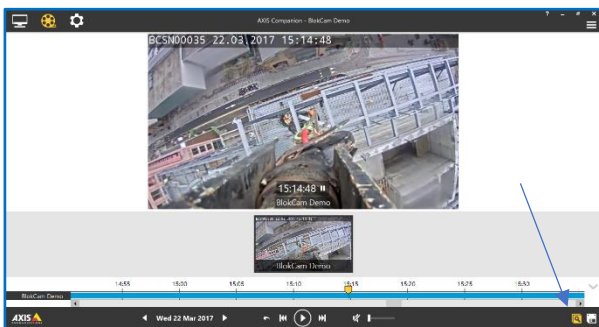

5. Use the slide bar and thumbnail icons to skip and view the footage frame by frame.

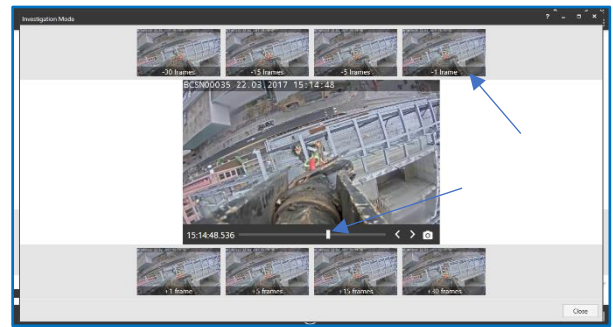

6. Select the Camera icon to save the individual image/frame.

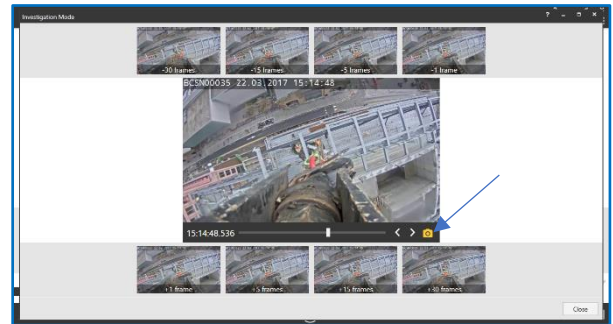

7. When the image is saved, the folder containing the file will open. Check the file is stored in the required location and close the folder using the 'X' at the top right of the 'Folder' page.

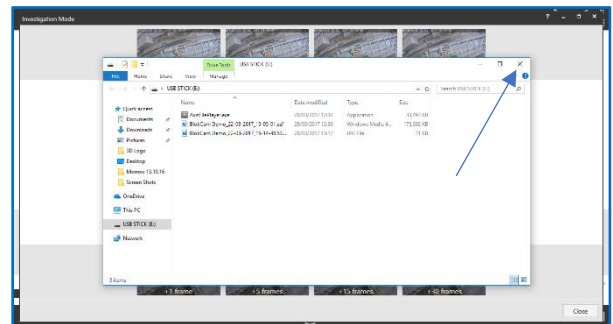

8. Repeat Steps 5 – 7 to extract more images if required.

9. Exit Investigation mode using the 'X' at the top right of the 'Investigation Mode' page.

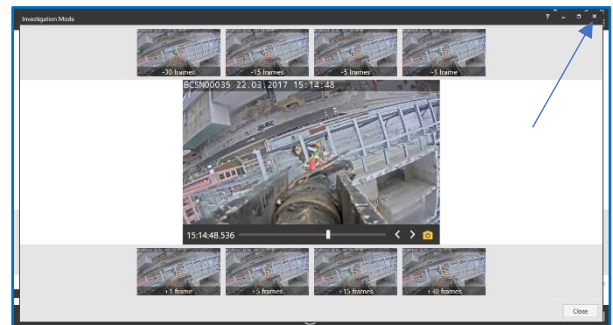

Logging Out & Disconnecting the Laptop

1. On the top right of the VMS software screen, locate and select the menu icon (the three horizontal bars).



2. On the drop-down menu select 'Log Out'.

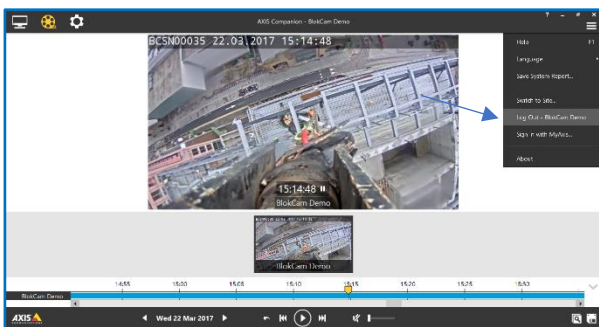

3. Locate and select the 'X' at the top right of the VMS to close application.

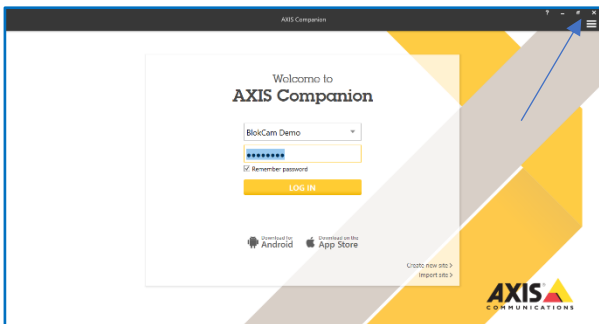

4. Disconnect the Cat5e RJ45 Patch Cable from the Laptop.
5. Disconnect the Cat5e RJ45 Patch Cable from the M3 – All in One Display.

Logging In

Foreword

Logging in is only possible once the VMS has been set up as detailed on page 14.

1. Connect to the network as detailed on page 13.
2. Open the VMS application software.
3. Select the arrow to activate the drop-down menu and select the desired 'Camera site'.

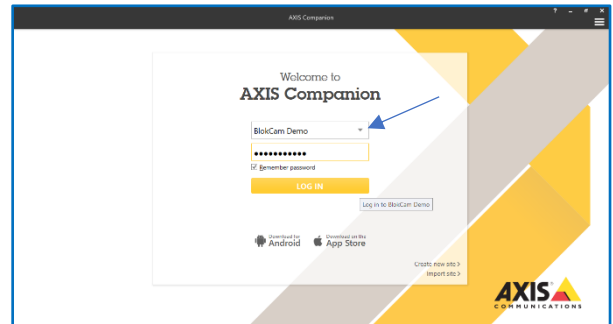

4. Type the password into the 'Site password' box.

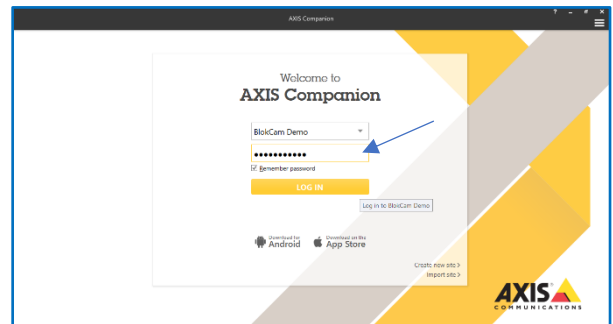

5. Select 'Remember password' box if required.

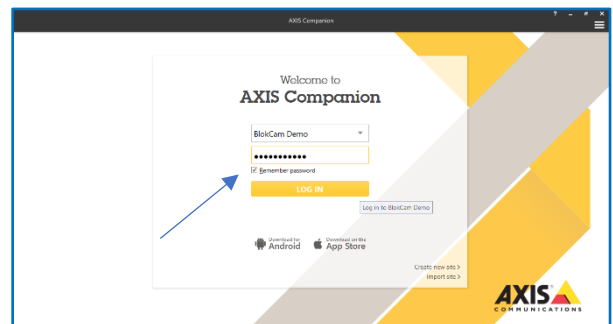

6. Select 'LOG IN'.

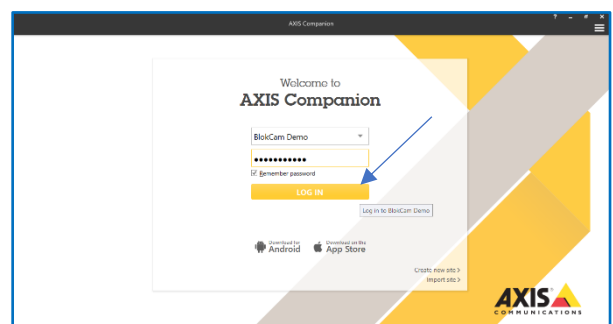

Office Link (Accessory)

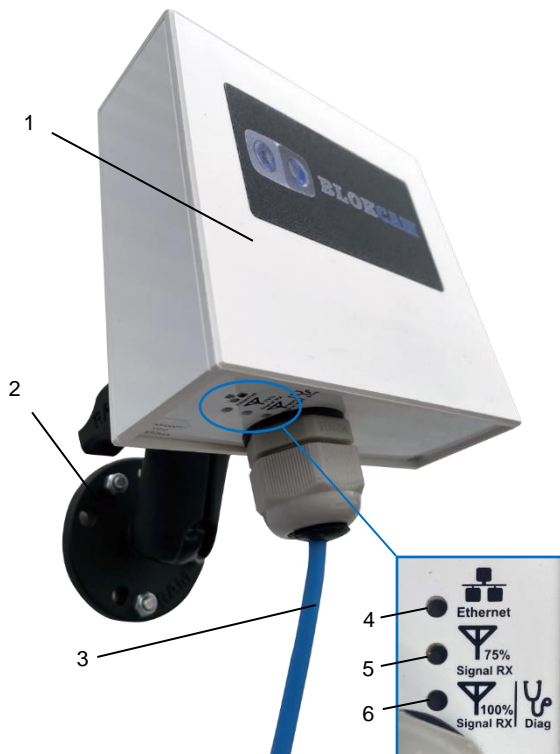

1. Front, receiving face.
2. Strap Mount / Magnetic Mount.
3. 75m / 4m Power and Data Cable.
4. Ethernet/Data LED.
5. 75% Signal Strength LED.
6. 100% Signal Strength LED.

Technical Specifications

Transmission Frequency: 5 GHz

Transmit Power: 19 to 25dBm

Receiver Sensitivity: -90 to -75 dBm

Size (Excluding Mounting Bracket) and Weight :

Height: 119mm (4.69 inches)

Width: 123mm (4.84 inches)

Depth: 45mm (1.77 inches)

Weight: 700g (1.55 pounds)

Casing: Plastic.

Power: 12-24Vdc, Passive PoE 24V

Power Consumption: Max 5.5 W

Antenna Connector: N/A (Built in Antenna)

Operating Conditions: -20 °C to 70 °C (-4 °F to 158 °F)

Humidity up to 5 to 95% (non-condensing)

Storage Conditions: -40 °C to 90 °C (-40 °F to 194 °F)

Humidity Max 90% (non-condensing)

IP Rating: IP 67 (with external ports connected)

Mount and Connect the Office Link

Foreword

The Office Link is powered over ethernet (POE) using the supplied POE Injector.

Pre-empt the position of the Office Link and consider:

- a. the position and/or intended position of other paired transceivers;
- b. Data cable length, route and distance to the host computer/laptop;
- c. Power supply availability;
- d. the dynamics of operation;
- e. possible changes to the surroundings.

1. Position the Office Link with the receiving face towards the transmitting transceiver.
2. Once the optimum position has been achieved, mount the Office Link to a fixed and secure point.
3. To avoid potential hazards, secure and tidy the cable from the Office Link to the anticipated Laptop location.
4. Connect the Power and Data Cable to the output socket on the POE Injector.
5. Connect the 1m Cat5e RJ45 Patch Cable to the input socket on the POE Injector
6. Connect the loose end of the 1m Cat5e RJ45 Patch Cable to the USB to LAN Adapter.
7. Connect the USB to Lan Adapter to a USB Port on the laptop.
8. Connect the POE Injector to a suitable mains supply socket with the supplied power cable.
9. Power up the POE Injector.
10. Power up the laptop.
11. For daily use, see the **Axis Companion** section.

When necessary reverse the above steps for removal.

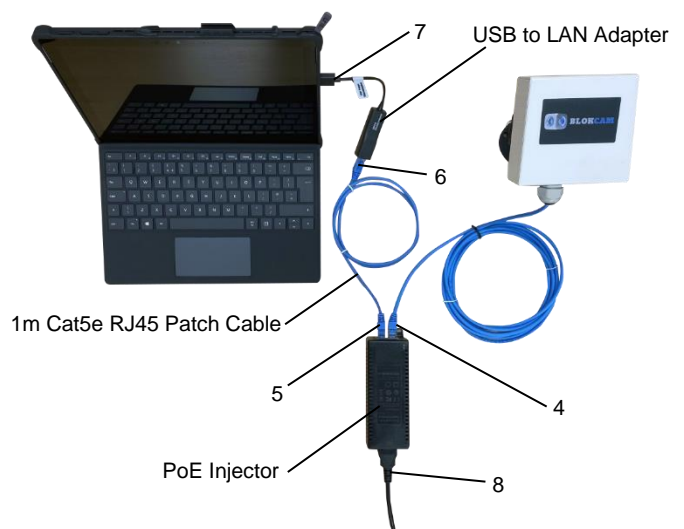

Axis Companion

Foreword

These instructions are only valid for the features within AXIS Companion Windows client.

How to access cameras from your computer

1. Open the AXIS Companion Application on the computer.
2. Select the site and log in with the site password. If the no sites are visible, connect the computer to the internet and sign into the end-user MyAxis account.

How to view live video



1. Go to 
2. Select which camera you want to view.

How to play recordings



1. Go to 
2. Use the timeline and calendar to find the recording.
3. Select the camera in the timeline and move the playback marker to the desired time.
4. Click Play.

How to save recordings



1. Go to 



2. Click 
3. Select a start and an end time for a camera recording.
4. Select which cameras to save recordings from.
5. Save the recording.

How to play saved recordings

To play a saved recording, open it with AXIS File Player.

When you save a recording, the AXIS File Player will be saved in the same folder. The AXIS File Player has a timeline showing what time the recording was made.

+44 1482 351546
info@blokcam.com
www.blokcam.com

