

Contents

3	Introduction	26	PB1 - Pendulum
3	The Process Explained	27	BM1 - BlokMag
3	Remarks		
4	What's Included		
4	Standard Configuration		
5	Technical Information		
5	System Number Coding Information		
6	X2 - Transmitter		
6	S4 - Sensor		
7	B5 - Battery		
7	R4 - Repeater		
7	P2 - Processor		
9	M2 - Monitor		
9	CS1 - Charging Station		
10	System Configuration		
11	Installation		
11	Mount & Secure the Transmitter		
12	Mount, Connect & Secure the Sensor		
12	Mount, Connect & Secure the Battery		
13	Mount & Secure the Repeater/s		
13	Connecting and Powering the Repeater/s		
14	Position and Connect the Processor		
14	Mount, Connect & Secure the Monitor		
14	Connecting the Charging Station		
15	Battery Charging Instructions		
15	Operating Instruction		
16	Accessing & Downloading Saved Data		
16	Connecting to the Network		
17	Set up the Video Management Software		
20	Selecting the Storage Location		
21	Viewing & Downloading the Recordings		
22	Viewing & Downloading the Screenshots		
23	Logging Out & Disconnecting the Laptop		
23	Logging In		
24	Accessories		
24	Office Link		
25	VC4 - V-Cam		
25	VC4a - V-Cam (Audio)		
26	FS1 - Footswitch		

Introduction

BlokCam ® is a wireless system that can be quickly and easily deployed to the hook block or boom tip of a crane. The sound and view from below the camera is then transmitted and received wirelessly via the antenna system to a screen in the cab. This allows the operator to see and hear the load and surroundings, giving an unobstructed, live, audio-visual feed of the critical areas that working in the blind would never allow.

The Process Explained

1. The Battery provides power to the Transmitter and the Sensor. The Sensor captures the audio-visual feed and sends it to the transmitter. Each component is magnetically attached and tethered to the desired surface. The signal is transmitted through one or more repeaters depending on the required configuration.
2. The Repeater is a modular transceiver which can be powered over ethernet (POE), by the BlokCam ® Battery or an alternative 12-24Vdc supply. The Repeater receives the wireless signal from the transmitter and relays the data back to a Processor and Monitor. The quantity and position of the repeater/s vary depending on the required configuration.
3. The final Repeater will be connected to, and powered over ethernet by the Processor. The Processor can be powered by mains or a 9-36vdc supply. The processor decodes the data and transfers the image and audio onto the Monitor. The Processor also powers the Monitor.

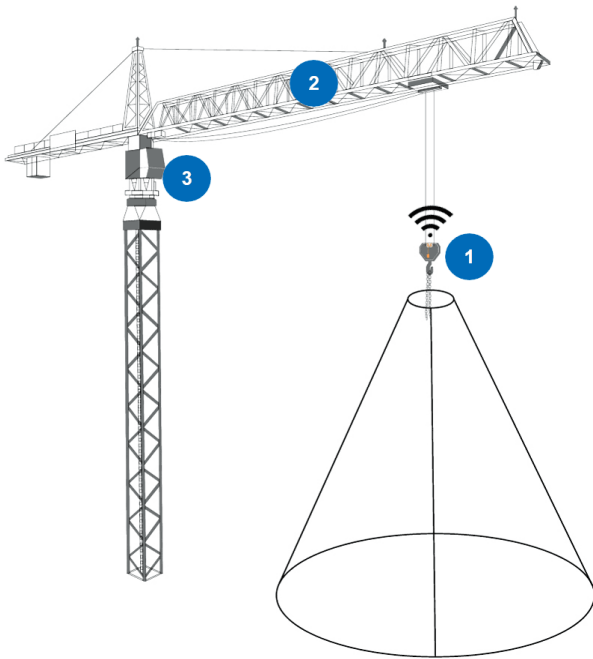

Remarks

1. Always adhere to the crane manufacturer's instructions.
2. BlokCam ® should be used to assist the operator's judgement, not replace it.
3. All aspects of installation, removal, charging, use and fault finding should only be carried out by trained and competent persons
4. Ensure BlokCam ® parts and components do not interfere with crane manufacturers and/or third-party components, parts and systems, moving or otherwise.
5. The hook block parts and components are magnetically mounted; prior to adverse weather conditions or in any situation where the hook block may come into contact with the crane and/or third-party components, moving or otherwise remove all components from the hook block.
6. Always ensure that lanyards are connected, and Rapid Links are tightened. Consider that the hook block may change configuration, shape and size.
7. High powered magnets in use. Neodymium magnets are permanent and strong, use correct protective equipment to avoid trapping hazard.
8. Working at Height. If possible, installation work should be completed at ground level, prior to the crane erection and installation of the jib. For working at height, please refer to regional and site-specific regulations and guidelines and ensure installation team are competent and adequately trained.
9. In Wi-Fi networking, a point-to-point wireless bridge lets users wirelessly connect two or more locations together. This bridge connects two or more locations to share data across the network.
10. BlokCam ® transceivers operate within the 5GHz band. For best results ensure a direct line of sight between all wireless transceivers and antennas.
11. Frequency selection and transmit power may vary. Please refer to regional regulations, guidelines and authorities to ensure legal operation.
12. A competent person should carry out pre-use checks prior to the commencement of work. Pre-use check sheets are available online from www.blokcam.com
13. Parts and components may differ from renders.
14. Manual subject to change without notice
15. Subject to Copyright

What's Included

X2 Crane Camera System

Part Number	Description	Quantity
50000	6mm Rapid Links	5
50001	3mm x 600mm Lanyard	4
50002	90 Degree N-Type Connector	3
50004	Ram Mount with U Bolts	1
50005	7 dBi Duck Bill Antenna	4
50006	3m HDMI Lead	1
50007	Strap Base with 1.5" Ball	1
50009	USB Memory Stick - 2GB	1
60000	Twin Suction Cup c/w Monitor Mount Stickers	1
60002	Double Socket Arm c/w Lanyard	2
60003	Blanking Plug	1
AN1	14dBi Flat Panel Antenna	1
B5	Battery Pack	2
C4X	Case Assembly - Model X	1
CS1	Charging Station	1
JC1	Jib Cable - 75m	1
M2	Monitor Assembly	1
P2	Processor	1
PC2	Power Cable – Battery to Transmitter/Repeater	1
PL-M2	Power Supply Unit (AC-DC)	2
R4	Repeater	1
S4	Sensor	1
X2	Transmitter	1

Technical Information

System Number Coding Information

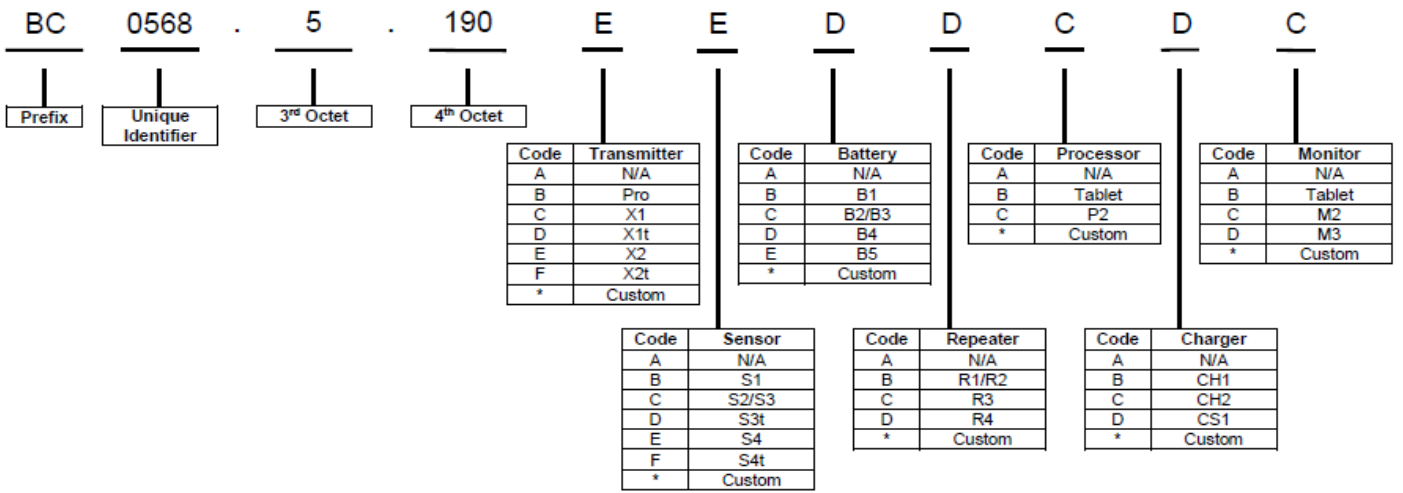

X2 - Transmitter

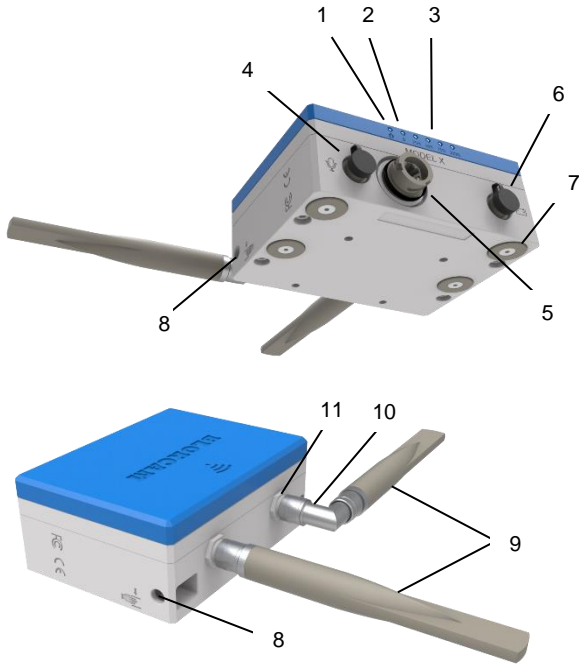

1. LED - Power
2. LED - Data
3. LED's – Signal Strength 25% - 100%
4. Sensor Socket – Audio
5. Sensor Socket - Video
6. Input Socket – 12-24Vdc
7. Mounting Magnets
8. Rapid Link Anchor Points
9. 7dBi Duck Bill Antenna
10. 90 Degree N-Type Connector
11. Antenna Ports

Technical Specifications

Video compression: H.264 (MPEG-4 Part 10/AVC) Baseline, Main and High Profiles Motion JPEG

Resolution: 1920x1200/1080

Frame Rate: 25/30 fps (50/60 Hz)

Video streaming: Multiple, individually configurable streams in H.264 and Motion JPEG

Image settings: Compression, colour, brightness, sharpness, contrast, white balance, exposure value, exposure control, exposure zones, local contrast, rotation, Corridor Format, text and image overlay, privacy mask, mirroring of images

Audio streaming: One-way

Audio input: External microphone input

Transmission Frequency: 5 GHz

Transmit Power: 19-25dBm

Size and Weight:

Height: 128mm (5.04 inches)

Width: 170mm (6.69 inches)

Depth: 71mm (2.8 inches)

Weight: 2100g (4.63 pounds)

Casing: Aluminium.

Power: 12-24Vdc

Power Consumption: Max 13.3 W

Antenna Connector: N-Type

Storage: One internal SD/SDHC/SDXC slot supporting memory card, 64Gb card included.

Operating Conditions: -20 °C to 60 °C (-4 °F to 140 °F)
Humidity 10-85% RH (non-condensing)

Storage Conditions: -40 °C to 65 °C (-40 °F to 149 °F)

IP Rating: IP 67 (with external ports connected)

S4 - Sensor

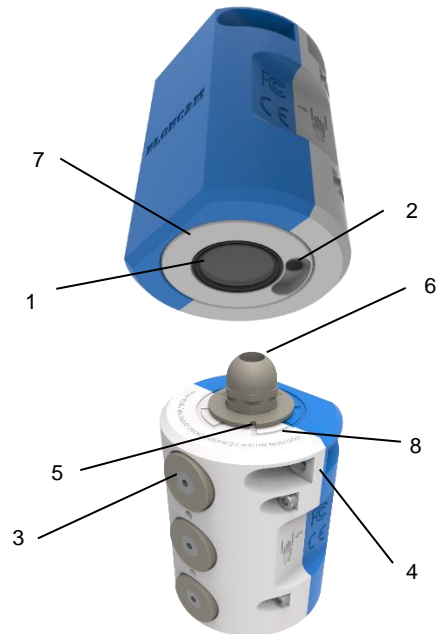

1. Video Sensor
2. Audio Sensor
3. Mounting Magnets
4. Rapid Link Anchor Points
5. Notch - Orientation Indicator Plate
6. Cable Gland
7. Sprung Loaded Rotary Boss
8. Map - Orientation Guide
9. Plug - Video Sensor (not shown)
10. Plug - Audio Sensor (not shown)

Technical Specifications

Video Sensor: Fixed Iris, 1080p

Resolutions: Max1920x1200/1080

Minimum illumination: Colour: 0.3 lux

Frame Rate: Max 50/60 fps (50/60 Hz)

Audio streaming: One-way

Audio input: External microphone input

Transmission Frequency: 5 GHz

Transmit Power: 19-25dBm

Size and Weight:

Height: 100mm (3.94 inches)

Width: 75mm (2.95 inches)

Depth: 69mm (2.72 inches)

Weight: 1250g (2.76 pounds)

Casing: Aluminium.

Power: Provided by Transmitter

Operating Conditions: -20 °C to 55 °C (-4 °F to 131 °F)

Humidity up to 75% RH (non-condensing)

Storage Conditions: -20 °C to 60 °C (-4 °F to 140 °F)

IP Rating: IP 67 (with external ports connected, excludes IP65

Audio Sensor)

B5 - Battery

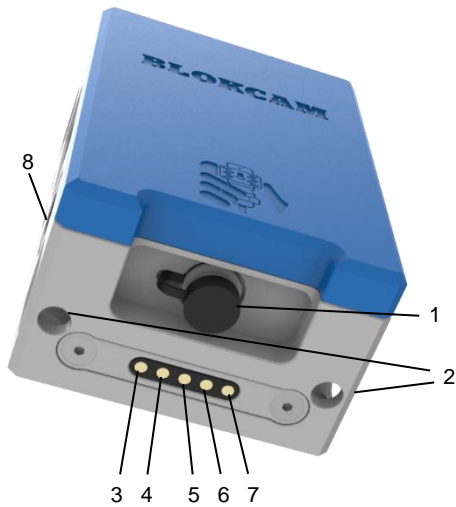

1. Output Socket (Pin 1 - Negative, Pin 2 - Positive)
2. Rapid Link Anchor Points
3. Recharge Docking Contact - Pin 1 (-) Negative
4. Recharge Docking Contact - Pin 2 (+) Positive
5. Recharge Docking Contact - Pin 3 (+) Thermistor
6. Recharge Docking Contact - Pin 4 (+) Charge station loop
7. Recharge Docking Contact - Pin 5 (+) Charge station loop
8. External Fuse Holder
9. Mounting Magnets (not shown)

Technical Specifications

Capacity: 19.2V 4.2Ah

Cell Manufacturer: Panasonic

Cell Type: Nickel-Metal Hydride Battery

Nominal Cell Voltage: 1.2V

Easy Access Fuse: 500mA

Size and Weight:

Height: 155mm (6.11 inches)

Width: 105mm (4.1 inches)

Depth: 71mm (2.8 inches)

Weight: 2400g (5.29 pounds)

MSDS: available from www.blokcaml.com

IP Rating: IP 67 (with external ports connected)

R4 - Repeater

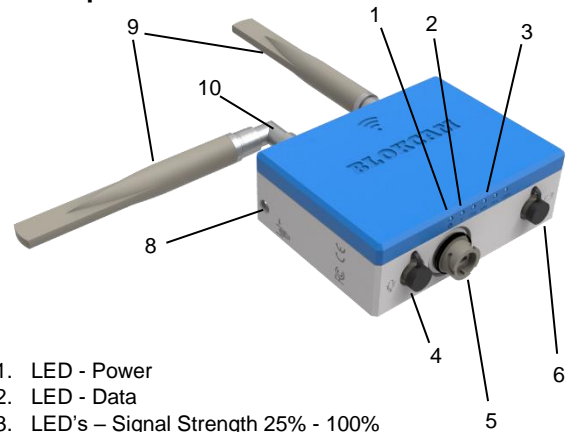

1. LED - Power
2. LED - Data
3. LED's - Signal Strength 25% - 100%
4. Socket - Blank
5. Socket - PoE LAN Port
6. Input Socket - 12-24Vdc
7. 1.5" Ball Joint (not shown)
8. Rapid Link Anchor Points
9. 7dBi Duck Bill Antenna
10. 90 Degree N-Type Connector
11. Antenna Ports (not shown)

Technical Specifications

Transmission Frequency: 5 GHz

Transmit Power: 19 to 25dBm

Receiver Sensitivity: -90 to -75 dBm

Size and Weight:

Height: 128mm (5.04 inches)

Width: 170mm (6.69 inches)

Depth: 58mm (2.28 inches)

Weight: 1800g (3.97 pounds)

Casing: Aluminium.

Power: 12-24Vdc, Passive PoE 24V

Power Consumption: Max 5.5 W

Antenna Connector: N-Type

Operating Conditions: -20 °C to 70 °C (-4 °F to 158 °F)

Humidity up to 5 to 95% (non-condensing)

Storage Conditions: -40 °C to 90 °C (-40 °F to 194 °F)

Humidity Max 90% (non-condensing)

IP Rating: IP 67 (with external ports connected)

P2 - Processor

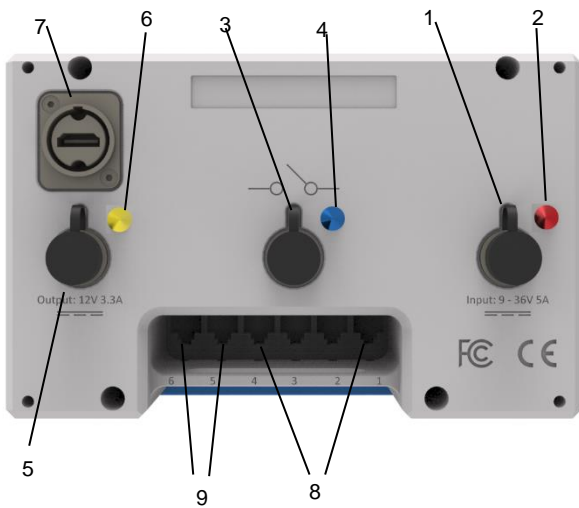

1. Input Socket - 9-36Vdc 5A
2. Input Socket - Colour Code - Red
3. Switch Socket - Multi Camera
4. Switch Socket - Colour Code - Blue
5. Output Socket - Monitor - 12Vdc 3.3A
6. Output Socket - Colour Code - Yellow
7. Output Socket - HDMI
8. POE Ports (Ports 1 - 4)
9. LAN Port (Ports 5 & 6)
10. LED - Power
11. LED - Data
12. LED - 1 - 6 Port related
13. Cable release port

Technical Specifications

Video Compression: H.264

Latency: >150mS

Frame Rate: Max 60 fps

Resolution: 1920 x 1080

Video and Audio Output: HDMI

Monitor Output: 12Vdc 3.3A

Size and Weight:

Height: 121mm (4.76 inches)

Width: 190mm (7.48 inches)

Depth: 161mm (6.34 inches)

Weight: 3800g (8.38 pounds)

Casing: Aluminium.

Power: 9-36Vdc 5A

Operating Conditions: 0 °C to 40 °C (32 °F to 104 °F)

Humidity up to 10% to 90% (non-condensing)

Storage Conditions: -40 °C to 70 °C (-40 °F to 158 °F)

Humidity 5% to 90% (non-condensing)

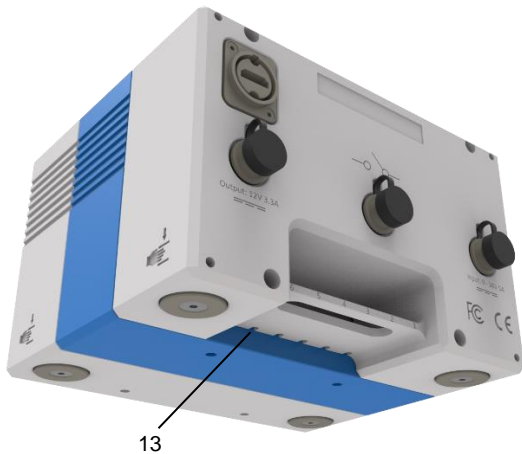
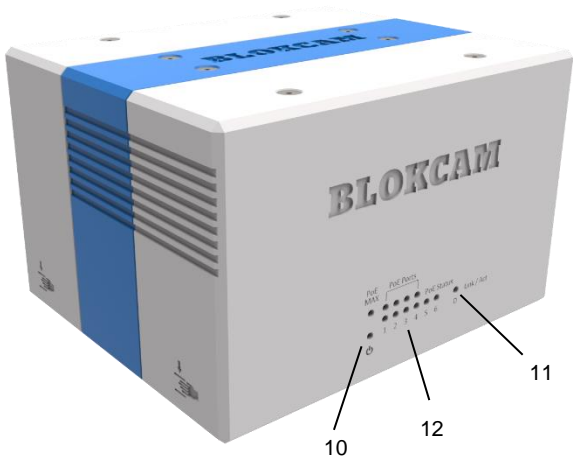

M2 - Monitor

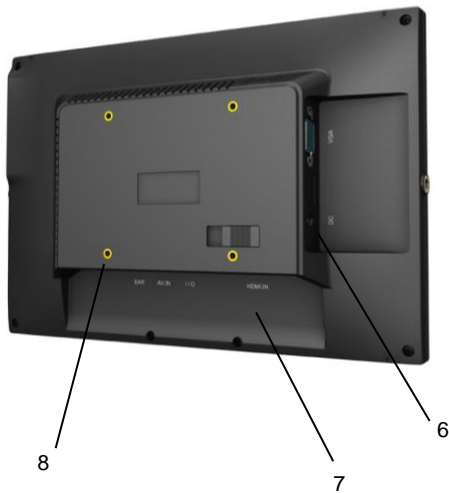

1. Button - Power
2. Button - Input
3. Button - FN (Function)
4. Button - MENU/EXIT
5. Navigation Wheel
6. Input Socket - 12Vdc
7. Input Socket – HDMI
8. 4 x Threaded Holes for Vesa Mount with 1.5" Ball Joint
9. Vesa Mount with 1.5" Ball Joint (Not Shown)

Technical Specifications

Screen Size: 10.1"
Aspect Ratio: 16:9
Resolution (pixels): 1920 x 1080
Scan Frequency (Hz): 60-72
Response time (ms): 20
Viewing Angle (degrees) 170 x, 170 y
Brightness (cd/m²): 350
Contrast Ratio: 800:1
LCD backlight: LED
Video and Audio Input: HDMI
Audio Output: <1.2W Speaker, 3.5mm Headphone Output
Size and Weight:
 Height: 121mm (4.76 inches)
 Width: 190mm (7.48 inches)
 Depth: 161mm (6.34 inches)
 Weight: 3800g (8.38 pounds)
Casing: Plastic
Power: 12Vdc 3.3A - Provided by Processor
Operating Conditions: -20 °C to 60 °C (-4 °F to 140 °F)

CS1 - Charging Station

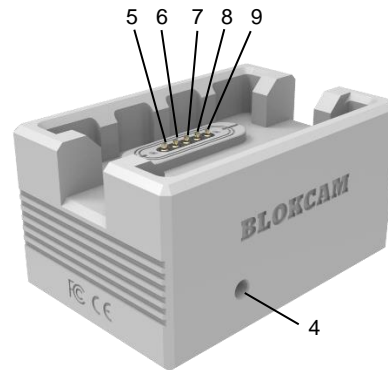
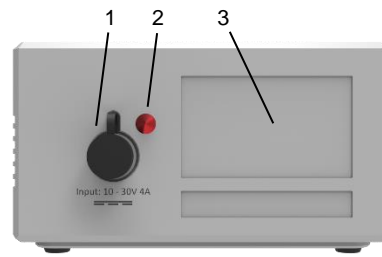

1. Input Socket - 10-30Vdc 4A
2. Input Socket - Colour Code – Red
3. Charge Indicator Plate
4. LED – Charge indicator
5. Recharge Spring Contact - Pin 1 (-) Negative
6. Recharge Spring Contact - Pin 2 (+) Positive
7. Recharge Spring Contact - Pin 3 (+) Thermistor
8. Recharge Spring Contact - Pin 4 (+) Charge station feed
9. Recharge Spring Contact - Pin 5 (+) Charge station return

Technical Specifications

Power: 10-30Vdc 4A
Size and Weight:
 Height: 85mm (3.35 inches)
 Width: 150mm (5.9 inches)
 Depth: 100mm (3.94 inches)
 Weight: 1650g (3.64 pounds)
Casing: Aluminium.
Internal Fuse: 5A

Charge Indicator Plate

Led	Mode	Output
Yellow	No battery	41v
Yellow	Initialization	50mA
Orange	Fast Charge	0.9A
Green/yellow	Top-off ch	130mA
Green	Trickle ch	50mA
Orange/Green	Error	50mA

System Configuration

Foreword

BlokCam ® X2 Crane Camera is a modular system. The required set up and installation are dependent on the machine and the environment.

The following illustration characterise the most common crane installation

TOWER CONFIGURATION - X2 SYSTEM

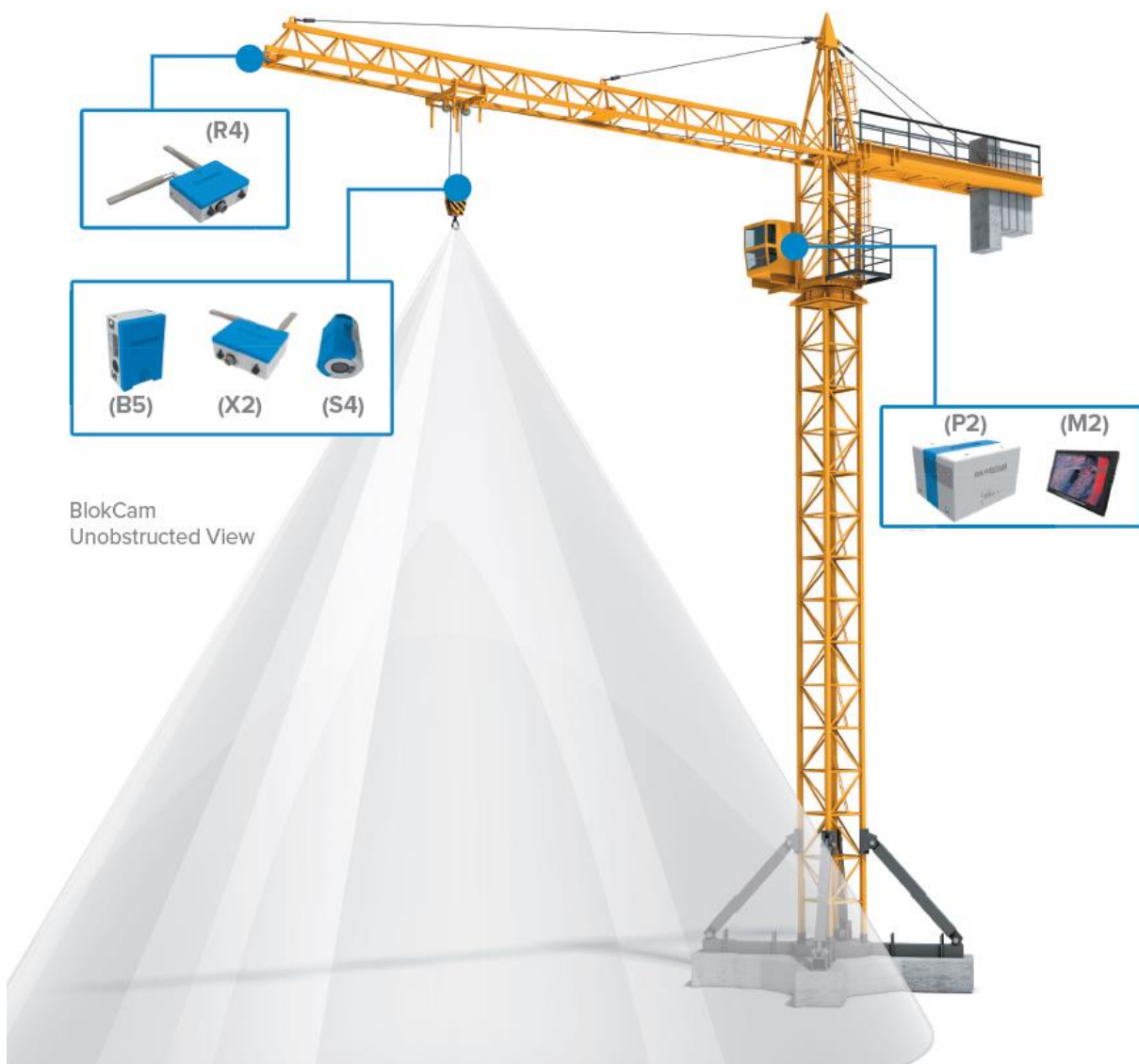

Installation

Foreword

Duck Bill Antennas are omni directional. For best performance, the orientation between the transmitting and receiving antennas must remain parallel and in-line (not offset), consistent and with a direct line of sight. Omni directional antennas do not emit a signal out of the tip of the antenna.

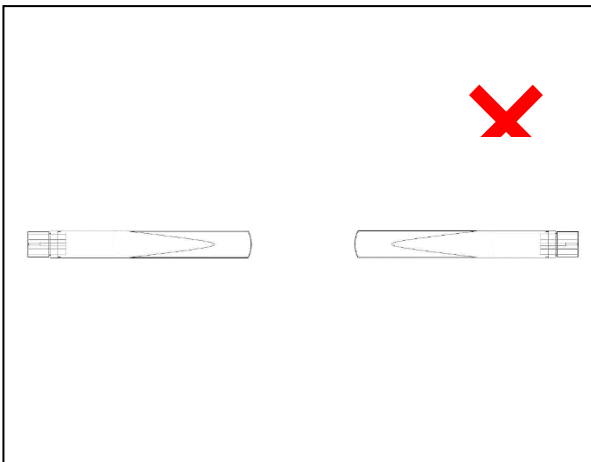
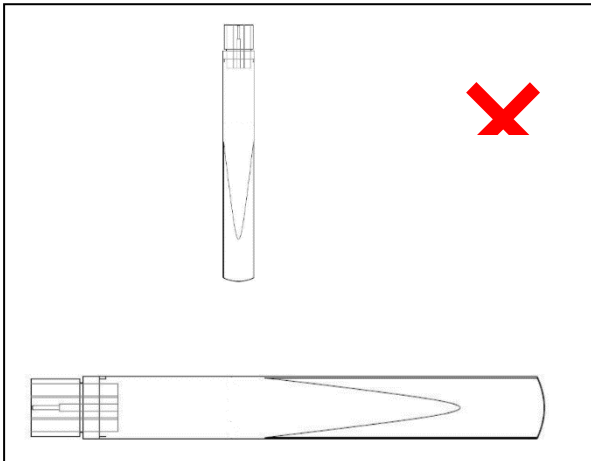
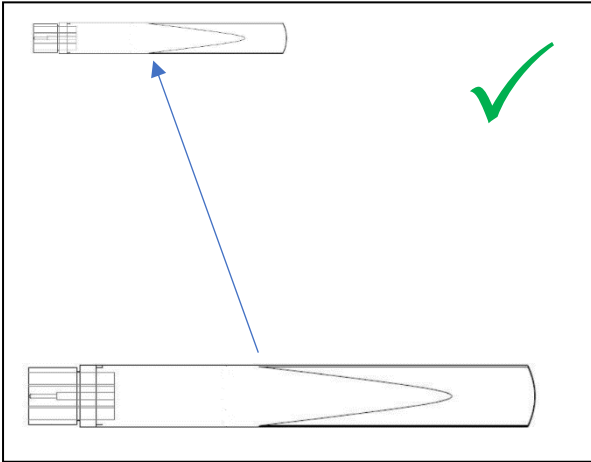

Mount & Secure the Transmitter

Pre-empt the position of the Transmitter and consider:

a. lanyard length and distance to a secure point receiving Repeater and, whilst ensuring a direct line of sight to the anticipated Repeater position.

1. Magnetically mount the Transmitter to a clean and flat surface.
2. Connect 2 x N-type right angle connector onto the antenna ports.
3. Connect a 7dBi Antenna to each of the N-type right angle connectors.
4. Both Antenna's should be horizontally positioned and at a right angle to each other.
5. Once the optimum position has been achieved, firmly tighten the antenna's and N-type connectors.
6. Fit Rapid Link to Transmitter anchor point.
7. Choke and secure a lanyard to a fixed and secure point.
8. Attach the loose end of Lanyard to the Rapid Link.
9. Firmly tighten the Rapid Link.

When necessary reverse the above steps for removal.

Mount, Connect & Secure the Sensor

Foreword

The installation and orientation of the camera must correctly correlate with the monitor and machinery movements. Following installation, test to ensure the relationship between the camera, monitor and machinery is accurate.

Pre-empt the position of the Sensor and consider:

- a. the sensor cable length and route;
 - b. the distance to the Transmitter;
 - c. the view from the intended position;
 - d. the lanyard length and distance to a secure point;
 - e. the orientation of the camera;
 - f. if a pendulum will be required to compensate for the dynamics of the machine.
1. Changing the orientation of the camera is a tool free operation. The Camera and Rotary Boss are sprung loaded into locator slots. To rotate the camera, lift, rotate and lower the Sprung Loaded Rotary Boss. Use the engraved text, map and notch as a guide to relocate correctly. As indicated the Rotary Boss will not rotate past 315 degrees due to the rotation stop.

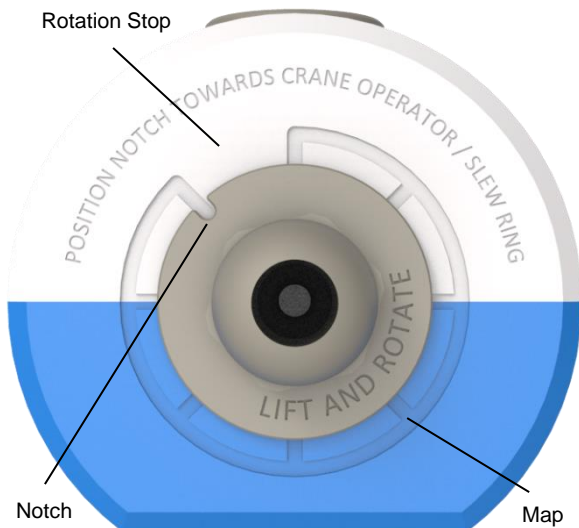

2. Magnetically mount the Sensor to a clean and flat surface.
3. Connect Video Sensor Plug to the Video Sensor Socket on the underside of the Transmitter.
4. Connect Audio Sensor Plug to the Audio Sensor Socket  on the underside of the Transmitter.
5. Secure the cable to a clean and flat surface using the pre-installed cable magnets.
6. Fit Rapid Link to Sensor anchor point.
7. Choke and secure a lanyard to a fixed and secure point.
8. Attach the loose end of lanyard to the Rapid Link.
9. Firmly tighten the Rapid Link.

When necessary reverse the above steps for removal.

Mount, Connect & Secure the Battery

Pre-empt the position of the Battery and consider:

- a. the power cable length and route;
 - b. the distance between the Battery and Transmitter;
 - c. the lanyard length and distance to a secure point;
 - d. that the battery is changed on a regular basis.
1. Magnetically mount the Battery to a clean and flat surface.
 2. Connect the Power Cable between the Output socket on the Battery and the Input Socket  on the Transmitter.
 3. Secure the cable to a clean and flat surface using the pre-installed cable magnets.
 4. Fit Rapid Link to Battery.
 5. Choke and secure a lanyard to fixed and secure point.
 6. Attach the loose end of lanyard to the Rapid Link.
 7. Firmly tighten the Rapid Link.

When necessary reverse the above steps for removal.

Mount & Secure the Repeater/s

Foreword

The Repeater is a modular transceiver that relays the wireless signal. The Repeater can be powered over ethernet (POE), by the BlokCam ® Battery or an alternative 12-24Vdc supply.

To protect against ingress, it is necessary to cap and seal all unused ports using the supplied blanking plug/s.

The installation, quantity, mounting, location, position and orientation are dependent on the required configuration.

Systems with multiple Repeaters must be connected in the correct series order.

The final Repeater in the series is connected to, and powered over ethernet by the Processor's POE Ports (Ports 1 – 4).

Always adhere to correct antenna alignment. Duck Bill Antennas are omni directional. For best performance, the orientation between the transmitting and receiving antennas must remain parallel and in-line (not offset), consistent and with a direct line of sight. Omni directional antennas do not emit a signal out of the tip of the antenna.

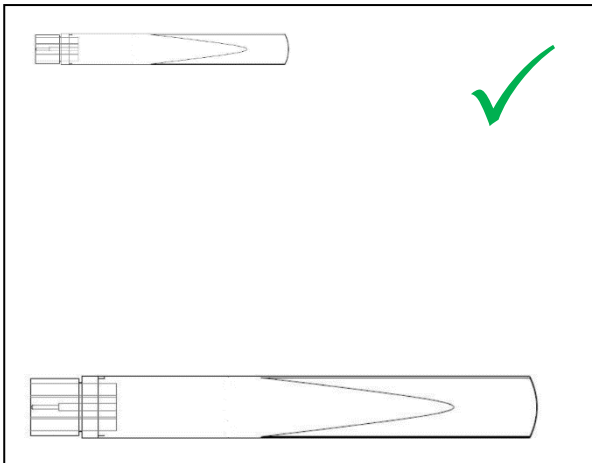

Pre-empt the position of the Repeater and consider:

- a. the data output method, wired or wireless;
 - b. the best suited power supply option;
 - c. the adjacent point to point relationship/s;
 - d. the antenna configuration;
 - e. mounting options;
 - f. the lanyard length and distance to a secure point;
 - g. which ports will need blanking;
 - h. the dynamics of machine.
1. Attach the best suited RAM Mount, Ball Joint Bracket to a fixed and secure point. If the supplied brackets are not suitable please seek advice from an authorised BlokCam ® dealer.
 2. Connect the Double Socket Ram Mount Arm complete with lanyard to the RAM Mount Ball Joint Bracket.
 3. Connect the Ball Joint attached to the rear of the Repeater to the Double Socket Ram Mount Arm.
 4. Fit Rapid Link to Repeater.
 5. Connect Double Socket Arm lanyard to Rapid Link.
 6. Choke and secure a second lanyard to fixed and secure point.

7. Attach the loose end of lanyard to the Rapid Link.
8. Firmly tighten the Rapid Link.
9. Connect 1 x N-type right angle connector onto an antenna port.
10. Connect a 7dBi Antenna to each of the ports.
11. Once the optimum point to point position has been achieved, firmly tighten the Ram Mount Brackets, Antenna's and N-type connector.

When necessary reverse the above steps for removal.

Connecting & Powering the Repeater/s

Wireless (battery powered)

1. Fit 1 x Lan Port Blanking Plug to the LAN Port Socket.
2. Mount, connect and secure the BlokCam ® Battery as instructed on page 11.

Wireless (alternative 12-24Vdc supply)

1. Fit 1 x Lan Port Blanking Plug to the LAN Port Socket.
2. Obtain any required permissions to tap into a suitable supply.
3. Connect the supply to the 12-24Vdc Input Socket. 

Wired (powered over ethernet)

1. Fit 1 x Input Socket Blanking Plug to the 12-24v Input Socket. 
2. Connect the Bayonet fitting from the '75m Jib Cable' to the LAN Port Socket on the Repeater.
3. Install and secure the cable from the Repeater to the anticipated Processor location using zip ties.

Position & Connect the Processor

Pre-empt the position of the Processor and consider:

- a. the IP Rating, the Processor must be kept indoors;
- b. the type of power supply, AC or DC;
- c. the PSU/Power Cable, length and route;
- d. the 75m Jib Cable length and route;
- e. the monitor position;
- f. the distance to the Monitor.

Systems with additional accessories may require considerations for:

- a. connecting and positioning additional cameras;
 - b. connecting and positioning a footswitch;
 - c. connecting and positioning a joystick;
 - d. connecting and positioning additional Repeaters;
 - e. connecting a laptop.
1. Connect the 75m Jib Cable from the Repeater to one of the Processor's POE Ports (Ports 1 – 4).
 2. Connect the 3m HDMI Lead to the HDMI Socket
 3. Connect the Monitor's Power Lead to the Yellow Output Socket (12Vdc 3.3A).
 4.
 - a. Connect the AC-DC Power Supply Unit and associated PSU Mains Lead between the Red Input Socket and a mains supply socket.

or

 - b. Connect the DC-DC Power Supply Cable between the Red Input Socket and a suitable DC supply socket.
 6. Route and secure the Monitor's HDMI and Power Lead from the Processor to the anticipated Monitor location using zip ties.

When necessary reverse the above steps for removal.

Mount, Connect & Secure the Monitor

Pre-empt the position of the monitor and consider:

- a. the mounting options;
 - b. the lanyard length and distance to a secure point;
 - c. the HDMI and power cable length and route.
1. Attach the best suited RAM Mount, Ball Joint Bracket to a fixed and secure point. If the supplied brackets are not suitable please seek advice from an authorised BlokCam® dealer.
 2. Connect the Double Socket Ram Mount Arm complete with lanyard to the RAM Mount Ball Joint Bracket.
 3. Route the Double Socket Arm Lanyard to a fixed and secure point. If necessary, fit and firmly tighten a Rapid Link to secure.
 4. Connect the Ball Joint attached to the rear of the Monitor to the Double Socket Ram Mount Arm.
 5. Connect the HDMI Cable to the HDMI Port.
 6. Connect the Power Cable to the 12Vdc Input Socket.
 7. Adjust the mounting system to achieve the desired position and firmly tighten the Ram Mount Brackets.

When necessary reverse the above steps for removal.

Connecting the Charging Station

Foreword

The charging station should be kept in a clean and dry environment.

1. Place the Charging Station on a clean, dry, flat and level surface. Ensure ease of access and egress and that the chosen position is within reach of a suitable power source.
2.
 - a. Connect the AC-DC Power Supply Unit and associated PSU Mains Lead between the Red Input Socket and a mains supply socket.

or

 - b. Connect the DC-DC Power Supply Cable between the Red Input Socket and a suitable DC supply socket.

When necessary reverse the above steps for removal.

Battery Charging Instructions

Foreword

The BlokCam ® X2 camera system runs on a non-hazardous battery. Under normal operating conditions each battery should provide approximately 12 hours of use. Certain operating conditions will decrease the standard runtime of the battery, including extreme hot or cold temperatures. The battery takes approximately 5 hours to fully charge.

Spare batteries should be kept in a clean and dry environment. BlokCam ® recommend swapping and charging the battery at the beginning of every shift.

1. Ensure charging contacts on the Battery and Charging Station are clean, dry and in good condition.
2. Ensure that the Charging Station is powered up.
3. Place the discharged battery into the Charging Station.



4. Use the Charge Indicator LED and Indicator Plate to monitor the charge condition.
5. When charged and/or required, lift the battery from the Charging Station.

Operating Instructions

Foreword

Operation is reliant on correct installation, charged batteries and/or reliable power source.

1. Power up the Processor.
2. The Monitor should power up automatically. If the Monitor does not power up automatically, press the power button on the right-hand side of the Monitor.
3. Wired Repeaters will power up automatically.
4. If applicable, power up any Wireless Repeater/s as instructed on page 12.
5. Power up the Transmitter. Mount, connect and secure a fully charged battery to the Transmitter as instructed on page 11.
6. Following completion of the start-up procedure the camera system should be fully functional and ready to use.
7. If required, re-position the sensor to achieve the desired view.

If you are experiencing difficulties, please refer to the fault finding guide.

Accessing & Downloading Saved Data

Foreword

To access and download saved data, ensure the BlokCam ® system and components are installed correctly and fully operational.

You will need a Laptop with VMS installed (Video Management Software), a Cat5e RJ45 Patch Cable of suitable length, basic networking and IT skills and access to the Processor. Laptop/System recommendations and VMS are available from www.blokcam.com

Connecting to the Network

1. Connect the Cat5e RJ45 Patch Cable between the laptop and LAN Port 5 or 6 on the processor.
2. To avoid conflict, ensure all other networks, wired or otherwise are disconnected and/or disabled.
3. Ensure the Laptop Internet Protocol Version 4 Properties are configured to 'Obtain an IP address automatically'.
4. Ensure the Laptop Internet Protocol Version 4 Properties are configured to 'Obtain DNS server address automatically'.

In some scenarios it may be necessary to manually configure the Laptops IP Address.

An IPv4 IP Address is made up of 4 Octets. The first, second and third Octet must be identical for connectivity across all paired units. The fourth Octet must be unique to avoid conflicting IP Addresses.

IPv4	1 st Octet	2 nd Octet	3 rd Octet	4 th Octet
Laptop	192	168	0	189
Camera	192	168	0	191
Transmitter	192	168	0	192
1 st Repeater	192	168	0	193
2 nd Repeater	192	168	0	194
Office Link	192	168	0	195

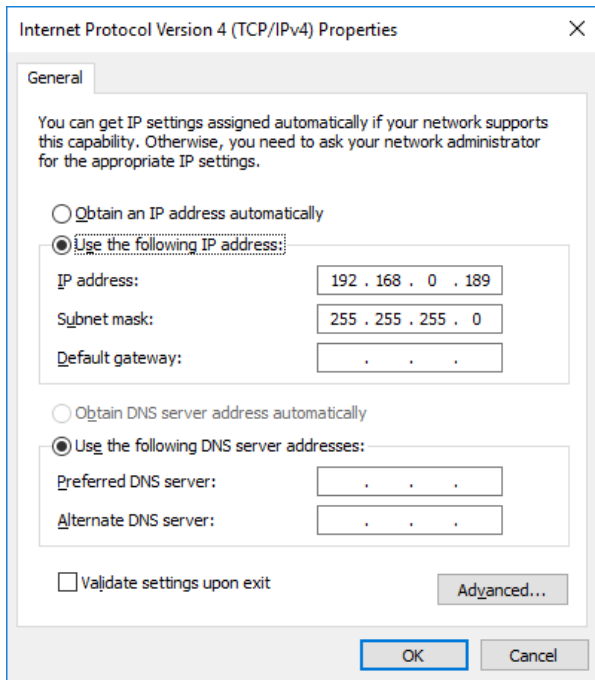

Set up the Video Management Software

1. Open the VMS application.
2. Select 'Create new site' or 'GET STARTED'.

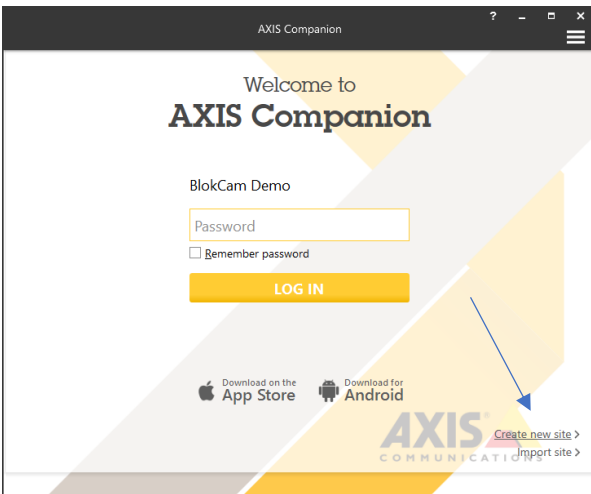

or



3. Choose and type your preferred site name into the 'Site name' box.



4. Obtain the Site password from an authorised BlokCam® dealer. Do not create a password. Creating a password will lead to system failure.

5. Type the procured password into the 'Site password' box.

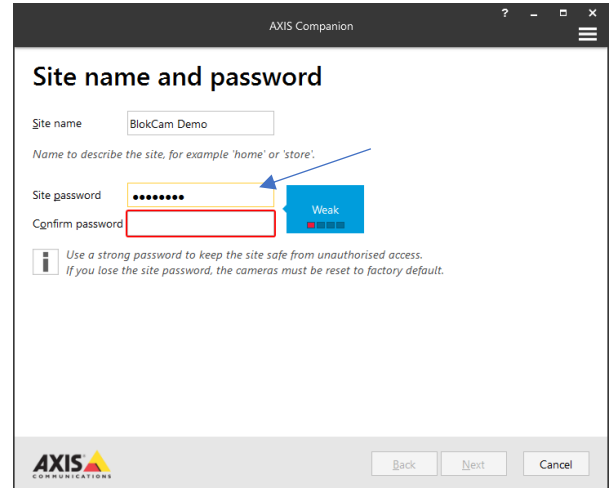

6. Re-type the procured password into the 'Confirm password' box.



7. Select 'Next'.

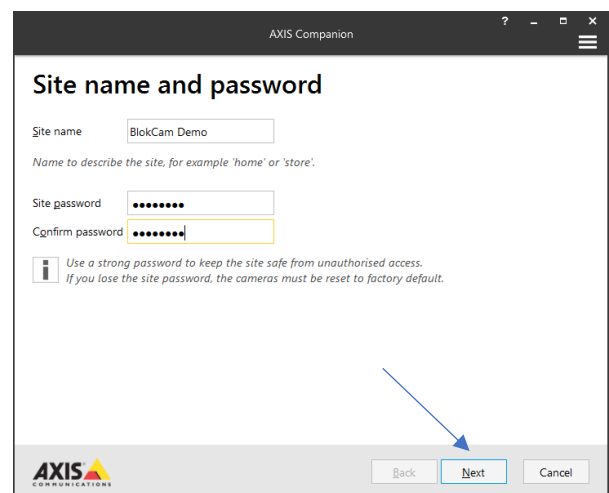

- The VMS will attempt to automatically search and discover all available network cameras. If the desired camera is discovered, skip to step 12.

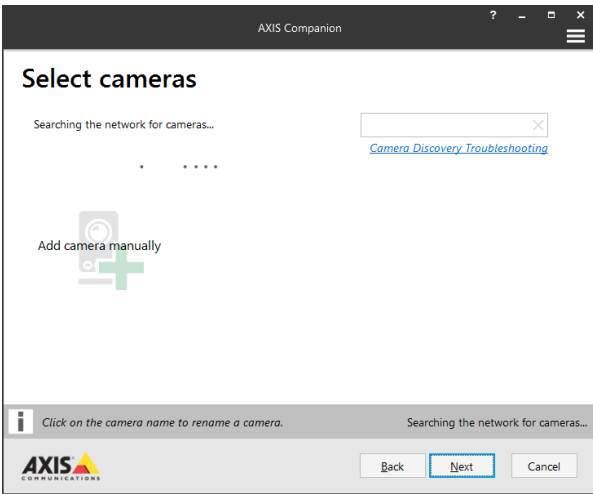

- If the desired camera is not automatically discovered, obtain the cameras IP Address from an authorised BlokCam® dealer and add the camera manually.

- Type the procured IP Address into the 'Enter camera address' box.

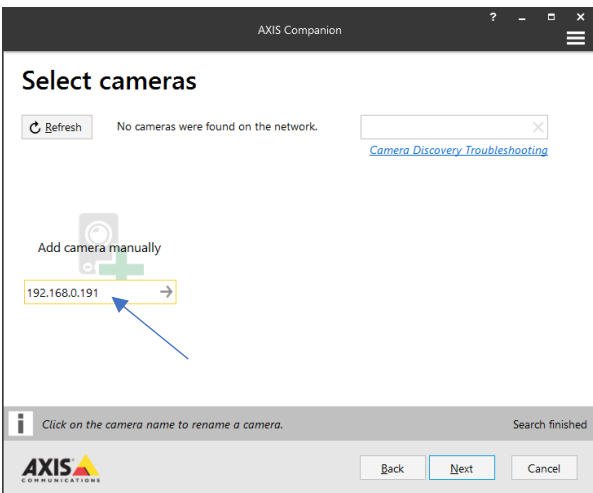

- Select the 'ADD' arrow to the right of the IP Address

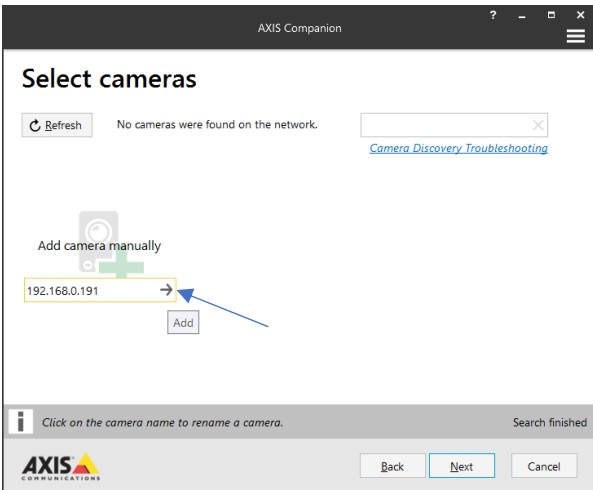

- Ensure the desired camera/s is/are selected.

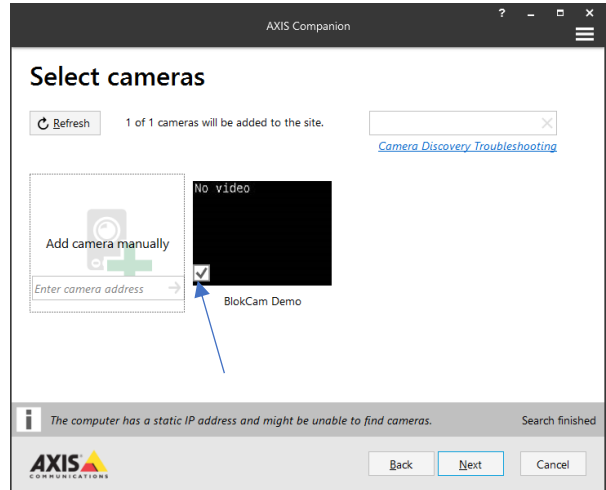

- Select 'Next'.

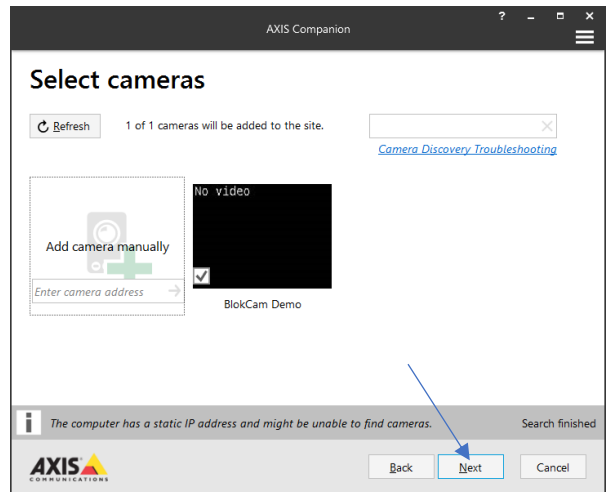

- Wait until the VMS contacts the selected camera/s.

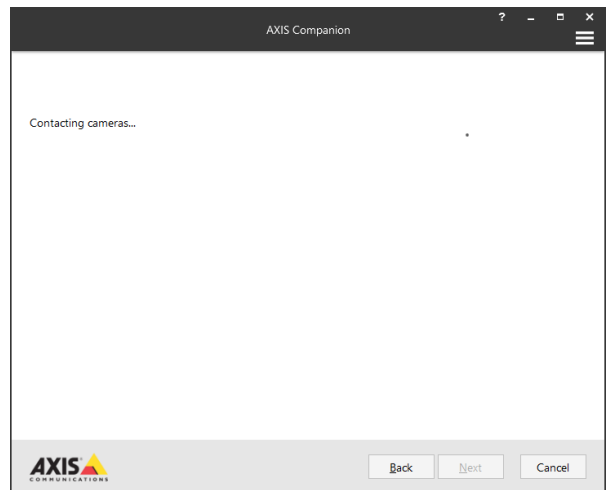

15. Select 'Finish' on the 'Ready to install' page.

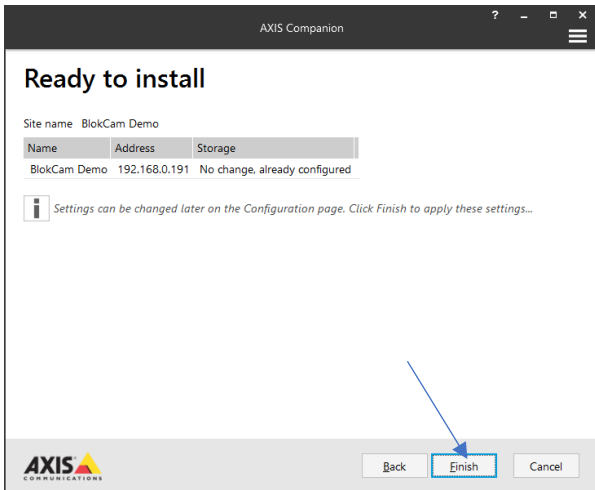

16. Wait until the VMS installs the selected camera/s.

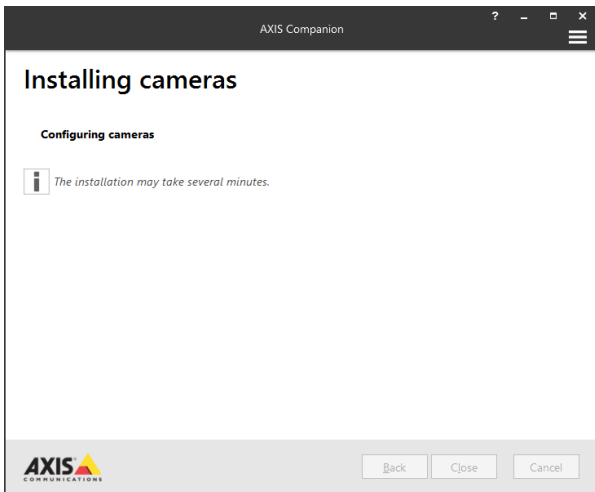

Selecting the Storage Location

1. Locate 3 icons on the top left of the VMS software screen. Select 'Go to Configuration'.

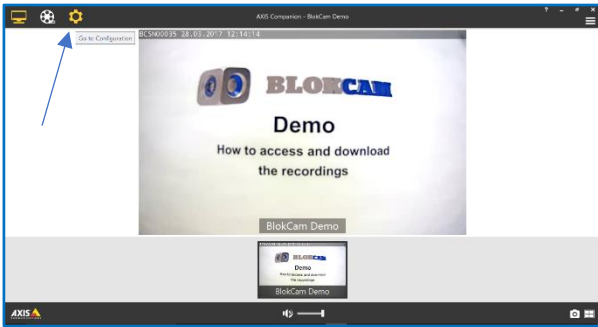

2. Select 'Customize' on the 'Go to Configuration' Screen.

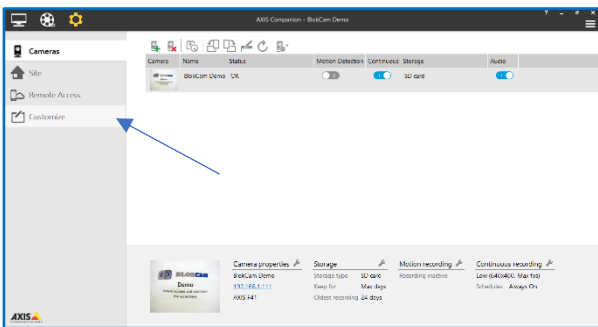

3. Under the heading 'Snapshot folder' locate and select 'Browse...'

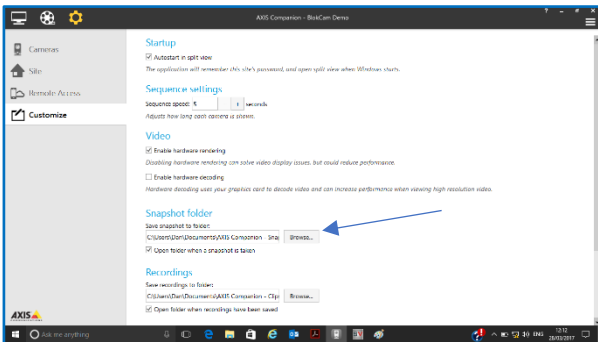

4. Select the desired storage location.

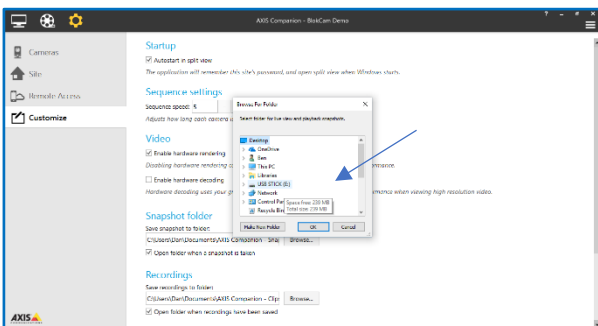

5. Select 'OK'.

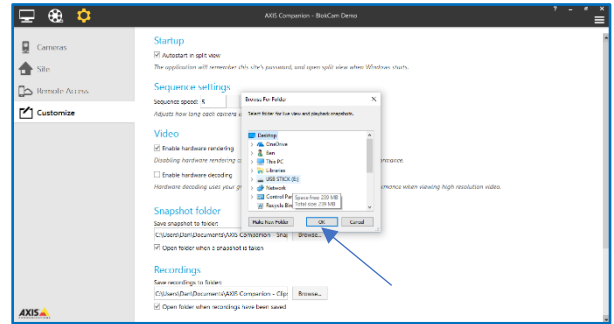

6. Check the storage location has changed and select 'Open folder when snapshot is taken' box.

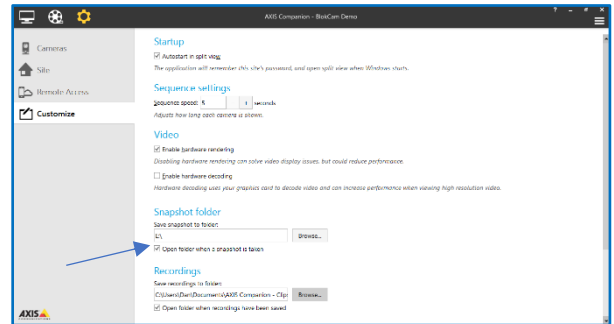

7. Repeat steps 3 – 6 for the 'Recordings' section.

Viewing & Downloading the Recordings

1. Locate the 3 icons on the top left of the VMS software screen. Select 'Go to Recordings'.

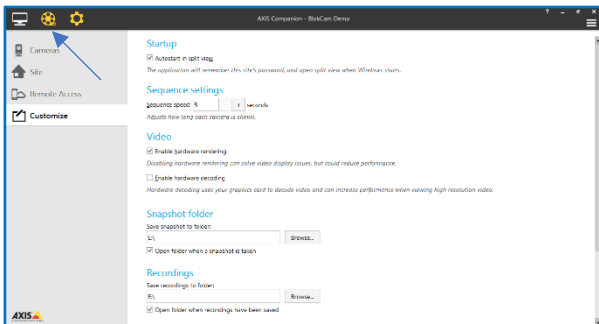

2. Select the footage from the date required by scrolling through the dates using the arrows left and/or right of the date displayed.

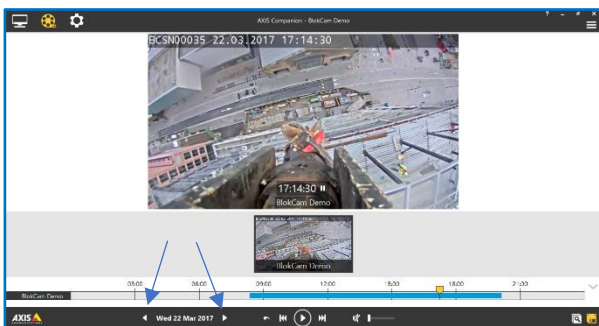

3. Locate and select the 'Save Recordings' icon on the bottom right of the VMS screen.

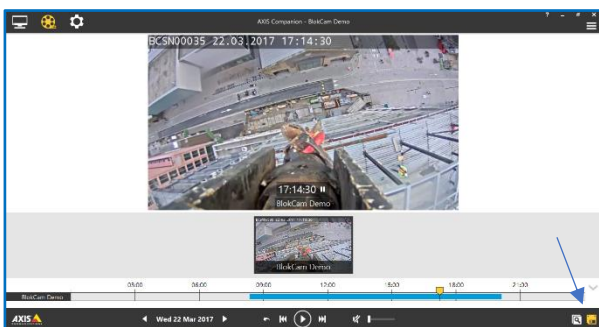

4. The blue time line indicates the duration of recording on the selected date. Use the grey trimming arrows to reduce or increase the duration of the required interval. For speed and storage reasons, please keep the download duration to a minimum.

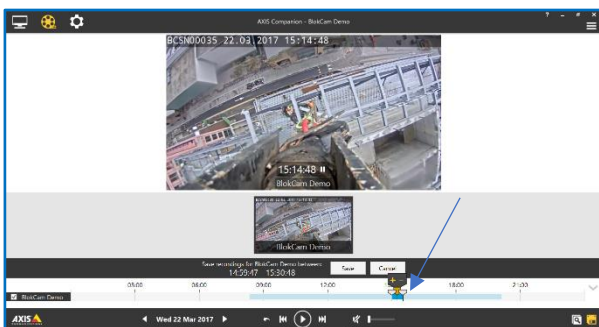

5. If required, select the yellow arrow. Then magnify the timeline using the + and/or - option/s.

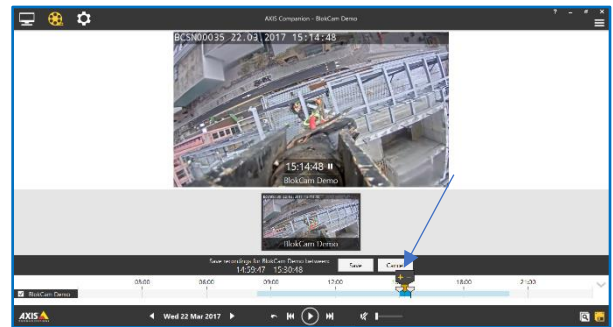

6. If necessary, repeat and refine step 4.

7. When the required interval has been found, select 'Save'.

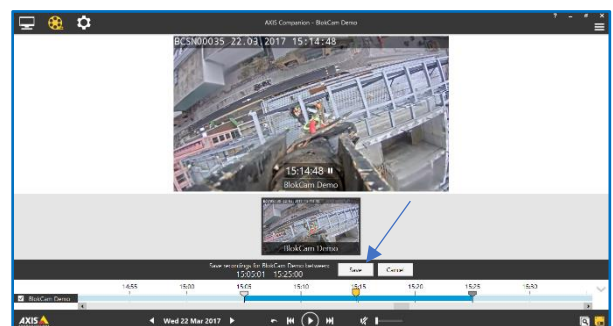

8. Wait whilst the selected recording interval is saved to the desired location.

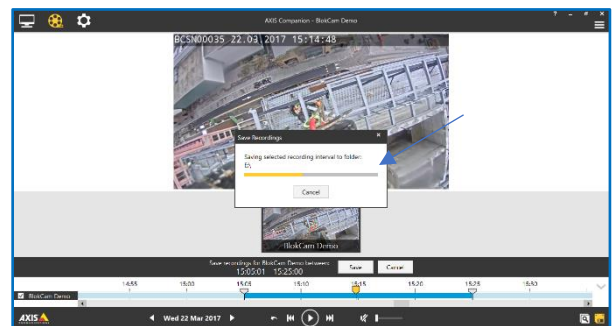

9. When the recording interval is saved, the folder containing the file will open. Check the file is stored in the required location and close the folder using the 'X' at the top right of the 'Folder' page.

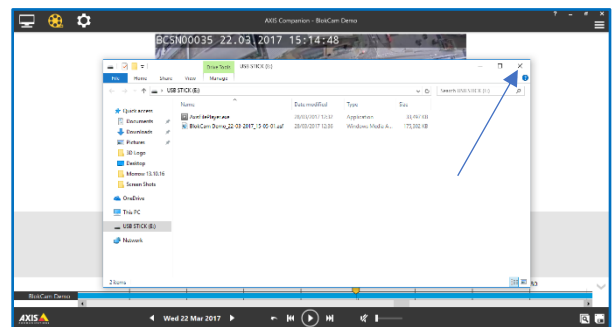

10. Repeat Steps 1 – 9 to extract more recording intervals if required.

Viewing & Downloading the Screenshots

1. Access the 'Go to Recordings' screen. Locate the 3 icons on the top left of the VMS screen. Select 'Go to Recordings'.

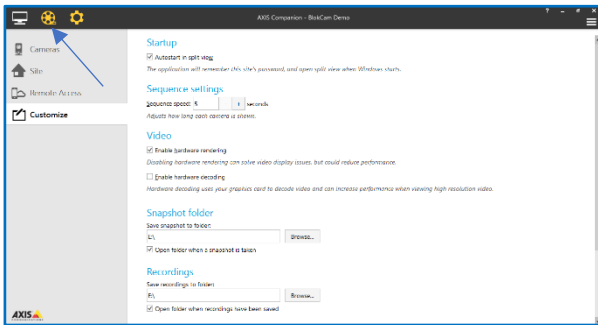

2. Select the footage from the date required by scrolling through the dates using the arrows left and/or right of the date displayed.

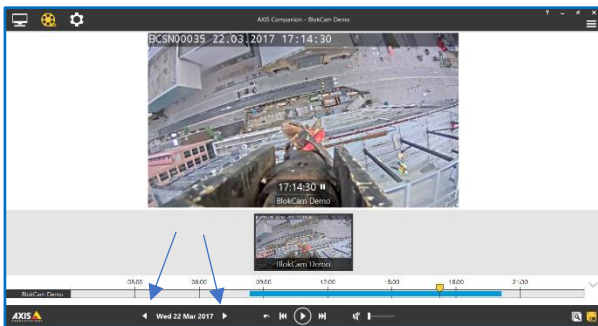

3. Select and slide the yellow arrow to magnify, locate and refine your search.

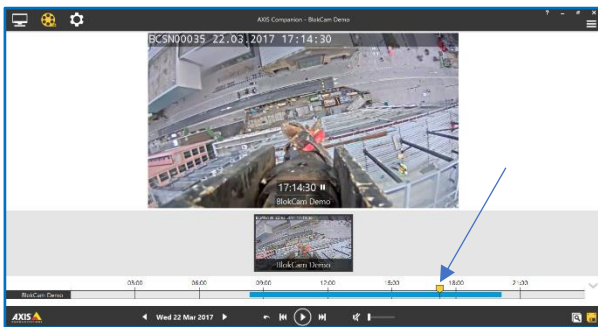

4. Locate the required image and select the 'Investigation Mode' icon on the bottom right of the VMS screen.

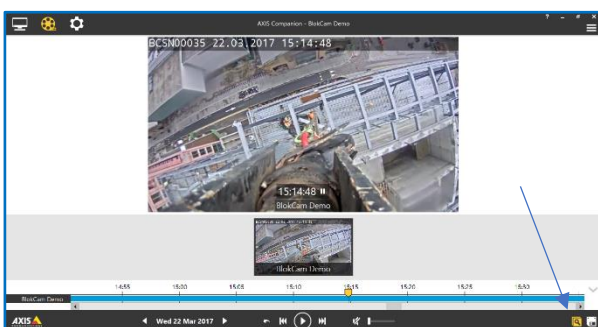

5. Use the slide bar and thumbnail icons to skip and view the footage frame by frame.

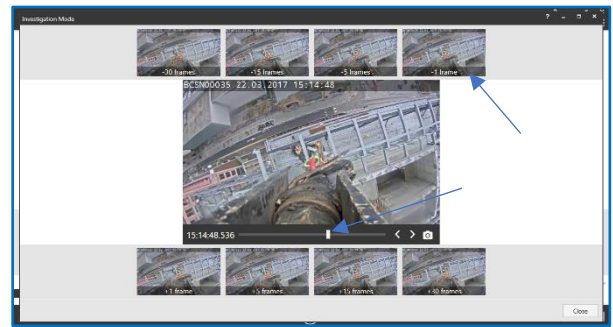

6. Select the Camera icon to save the individual image/frame.

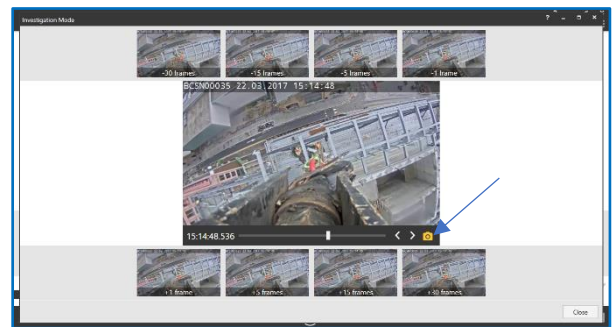

7. When the image is saved, the folder containing the file will open. Check the file is stored in the required location and close the folder using the 'X' at the top right of the 'Folder' page.

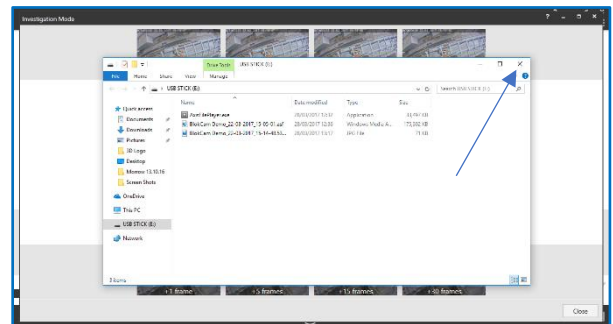

8. Repeat Steps 5 – 7 to extract more images if required.

9. Exit Investigation mode using the 'X' at the top right of the 'Investigation Mode' page.

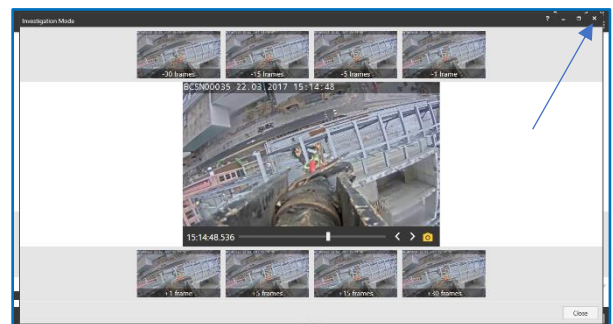

Logging Out & Disconnecting the Laptop

1. On the top right of the VMS software screen, locate and select the menu icon (the three horizontal bars).



2. On the drop-down menu select 'Log Out'.

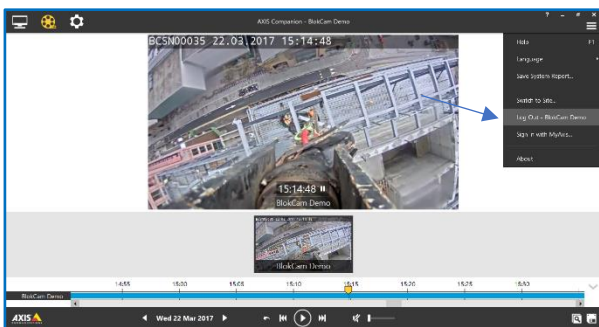

3. Locate and select the 'X' at the top right of the VMS to close application.

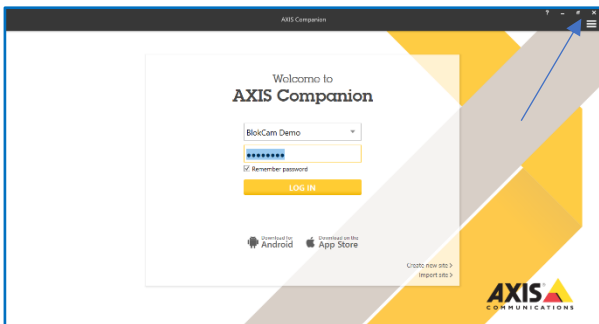

4. Disconnect the Cat5e RJ45 Patch Cable from the Laptop.
5. The Processor is manufactured with an anti-tamper system. Insert a suitable tool (not supplied) into the cable release port, push the patch cable latch and simultaneously disconnect the Cat5e RJ45 Patch Cable from the Processor.

Logging In

Foreword

Logging in is only possible once the VMS has been set up as detailed on page 16.

1. Connect to the network as detailed on page 15.
2. Open the VMS application software.
3. Select the arrow to activate the drop-down menu and select the desired 'Camera site'.

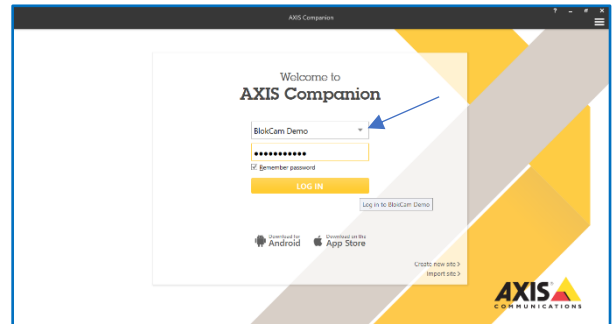

4. Type the password into the 'Site password' box.

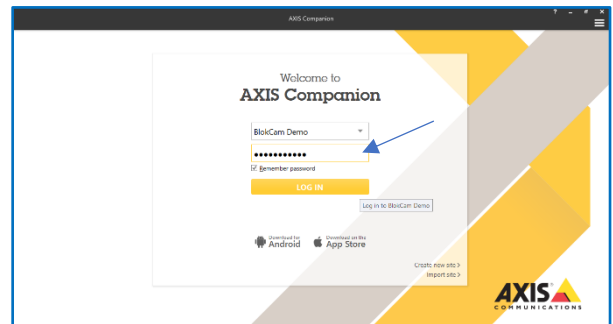

5. Select 'Remember password' box if required.

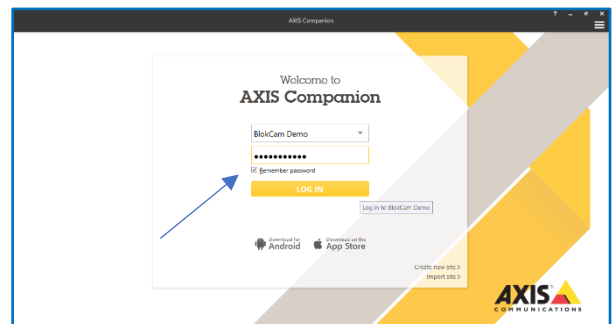

6. Select 'LOG IN'.

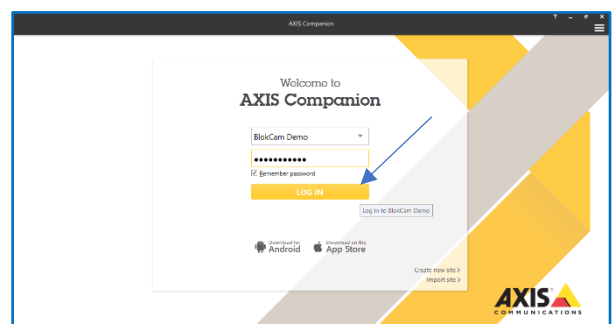

Accessories

OL1 – Office Link

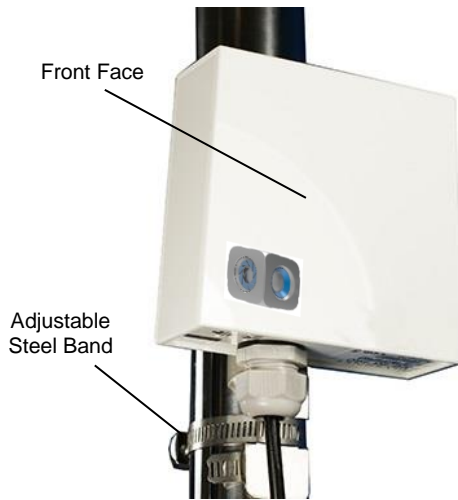

Overview

BlokCam Office Link allows the data from your BlokCam to be captured in a site office for site and crane monitoring and surveillance. Your host computer could monitor and record data from multiple systems. BlokCam Office Link and software comes with many additional benefits and features including:

- Quick and easy to install;
- Take screen shots;
- Extract footage for training and investigation;
- Integrated 12dBi antenna;
- Designed for outdoor applications;
- 1km transmission distance;
- Rugged mounting bracket;
- IP66.

Installation

Foreword

Office links are factory programmed and paired to a specific Repeater. Please seek advice from an authorised BlokCam ® dealer for further programming and pairing options.

The Office Link is powered over ethernet (POE) using the supplied POE Injector or a suitable network switch.

To access and download data via the Office Link, ensure the BlokCam ® system and components are installed correctly and fully operational. Ensure the front face of the Office Link is facing, and has a direct line of sight to the paired Repeater.

You will need a Laptop with VMS installed (Video Management Software), a Cat5e RJ45 Patch Cable of suitable length and basic networking and IT skills. Laptop/System recommendations and VMS are available from www.blokc.com

Pre-empt the position of the Office Link and consider:

- a. the adjacent point to point relationship;
- b. mounting options;
- c. cable length, route and distance to the host computer;
- d. the dynamics of machine;
- e. possible changes to the surroundings.

1. Use the adjustable steel band to mount the Office Link to a fixed and secure point. If the supplied brackets are not suitable please seek advice from an authorised BlokCam ® dealer.

2. Once the optimum point to point position has been achieved, firmly tighten the adjustable steel bracket.
3. Secure the cable from the Office Link to the anticipated Laptop location using zip ties.
4. Connect the cable to the output socket on the POE Injector.
5. Connect the Cat5e RJ45 Patch Cable between the POE Injector and the laptop.
6. Connect the POE Injector to a suitable mains supply socket.
7. Power up the POE Injector.
8. Power up the laptop and revert to the '**Accessing & Downloading Saved Data**' section to complete installation.

When necessary reverse the above steps for removal.

VC4 - V-Cam



Overview

The Versatile-Cam is our hardwired option which gives you the ability to expand your BlokCam ® system to include additional Sensors. The build quality of the VC4 coupled with its non-intrusive size and mounting versatility means it can be deployed in seconds and used in a multitude of scenarios. Ideal for visual monitoring and data logging of the Hoist Drum, Luffing Drum, Slew Ring, Tail Swing and the Operators Cab.

- Quick and easy to install;
- Uses high powered neodymium magnets;
- The lens is auto-focus and always gives clear views;
- HD1080p Resolution;
- Durable all-weather design, manufactured to IP66;
- Available with audio sensor as the (VC4a).

Installation

Foreword

V-Cam's are factory programmed with a specific IP Address and paired to a specific system. Please seek advice from an authorised BlokCam ® dealer for further programming and pairing options.

The V-Cam is powered over ethernet (POE) via a connection to a Processor POE Port (Ports 1 – 4).

The installation of two or more cameras will require the installation of a footswitch or similar control mechanism to select the desired camera/s in single or split screen mode.

Pre-empt the position of the V-Cam and consider:

- a. the sensor cable length and route;
- b. the distance to the Processor;
- c. the view from the intended position;
- d. the lanyard length and distance to a secure point;
- e. the orientation of the camera;
- f. the dynamics of the machine.

1. Magnetically mount the V-Cam to a clean and flat surface.
2. Choke a lanyard to the V-Cam and secure with a zip tie.
3. Attach the loose end of the Lanyard to a fixed and secure point. If necessary, fit and firmly tighten a Rapid Link to secure.
4. Secure the cable from the V-Cam to the Processor using zip ties.

5. Connect the hardwired LAN Cable from the V-Cam to one of the Processor's POE Ports (Ports 1 – 4).
6. After start up, if required, re-position the sensor to achieve the desired view.

When necessary reverse the above steps for removal.

VC4a - V-Cam (Audio)



Overview

The VC4a is our hardwired camera with a built-in microphone. The build quality coupled with its non-intrusive size and mounting versatility means it can be deployed in seconds. The VC4a is most commonly used for audio-visual monitoring and data logging of the Operators Cab.

- Quick and easy to install;
- Uses high powered neodymium magnets;
- The lens is auto-focus and always gives clear views;
- HD1080p Resolution;
- Built-in microphone;
- PIR motion sensor;
- Bracket for wall and corner mount;
- Day & night with IR illumination.

Installation

See VC4 - V-Cam Installation Instructions

FS1 - Footswitch



Overview

When using multiple cameras, the Footswitch provides the hands-free operation that a crane operator needs to flick between single and split screen mode.

- Quick and easy to install;
- IP67.

Installation

Pre-empt the position of the switch and consider:

- a. the Footswitch cable length and route;
- b. the distance to the processor.

1. Place the switch in a suitable position for the operator.
2. Secure the cable from the Footswitch to the Processor using zip ties.
3. Plug the Footswitch into the Processor's Blue Multi Camera Switch Socket

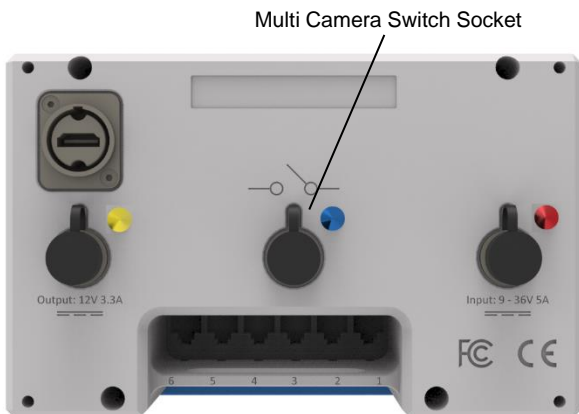

When necessary reverse the above steps for removal.

BP1 - Pendulum

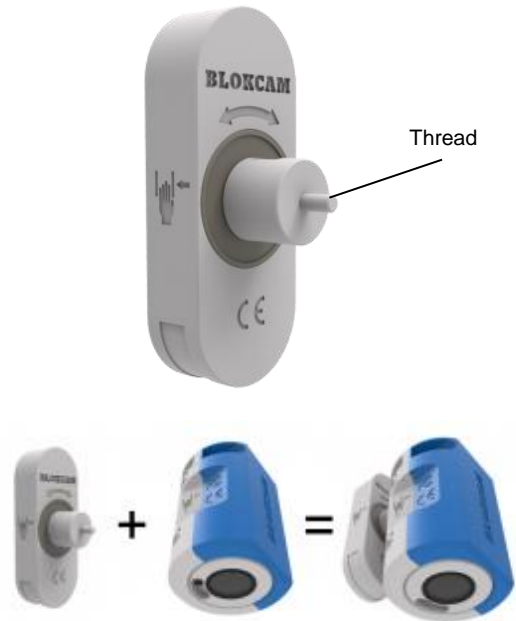

Overview

BP1 allows you to install your existing sensor to the boom tip of a crane. The pendulum allows the sensor to pivot and focus on the hook block, load and surrounding area regardless of the angle of the jib.

Installation

Foreword

Some assembly required, Installation of the Pendulum requires the use of medium strength thread lock and a 24mm spanner/wrench.

1. Follow the instruction on the thread lock.
2. Apply thread lock to the Pendulum thread.
3. Screw the Pendulum thread into the rear, top recess of the Sensor, as pictured below and tighten using a spanner/wrench.



4. Allow the thread lock to dry thoroughly prior to use.
5. Install and secure the sensor as instructed on page 11.
6. Ensure the sensor cable does not limit or dictate the rotation of the Pendulum.

BM1 - BlokMag

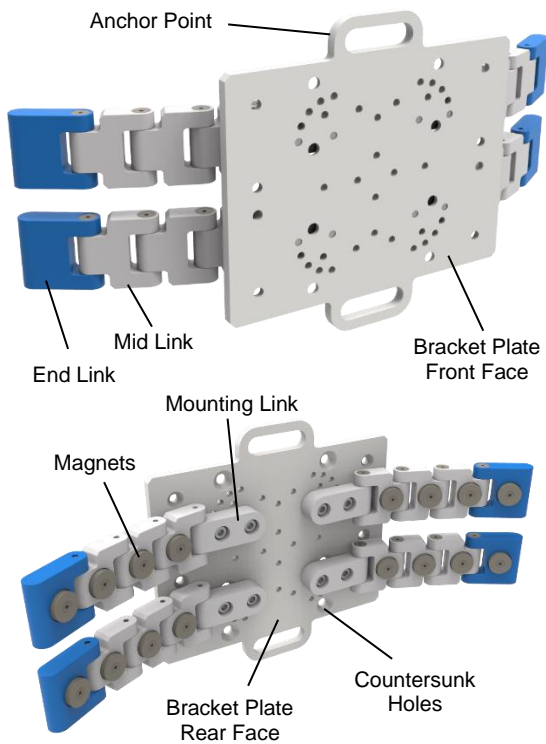

The above images show the Transmitter BlokMag® (BM1-X) configured for installation on a cylindrical surface.

The below images show the Transmitter BlokMag® (BM1-X) configured for installation on a spherical surface.

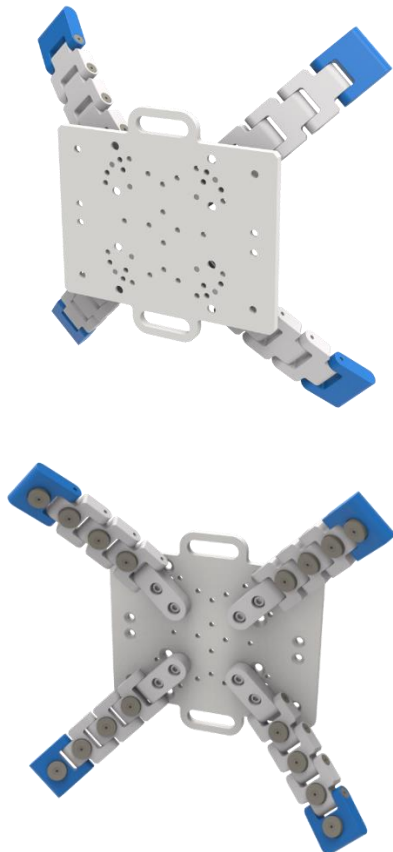

Overview

Attach your crane camera system to a curved surface. Flat, spherical, cylindrical, narrow, short or tall, our modular BlokMag® system allows flat surfaces to mate with curved surfaces flawlessly. Mount your Transmitter, Sensor and/or Battery to the matching BlokMag® magnetically, or if preferred, use the countersunk holes on rear of the Bracket Plate using countersunk fixings.

Assembly

Foreword

Some assembly required. BlokMag's® are dispatched partially assembled to improve modularity and increase installation options.

Each Bracket Plate comes with four Link Arms and associated fixings. Link Arms are factory assembled and retained with high strength thread lock. Each Link Arm includes :

- 1 x Mounting link
- 3 x Mid Link's, complete with magnets
- 1 x End Link, complete with magnet

Multiple threaded holes on the Bracket Plate allows the Link Arms to be installed at increments of 22.5-degree angles. You will need a 3mm hex key to fit the Link Arms to the Bracket Plate.

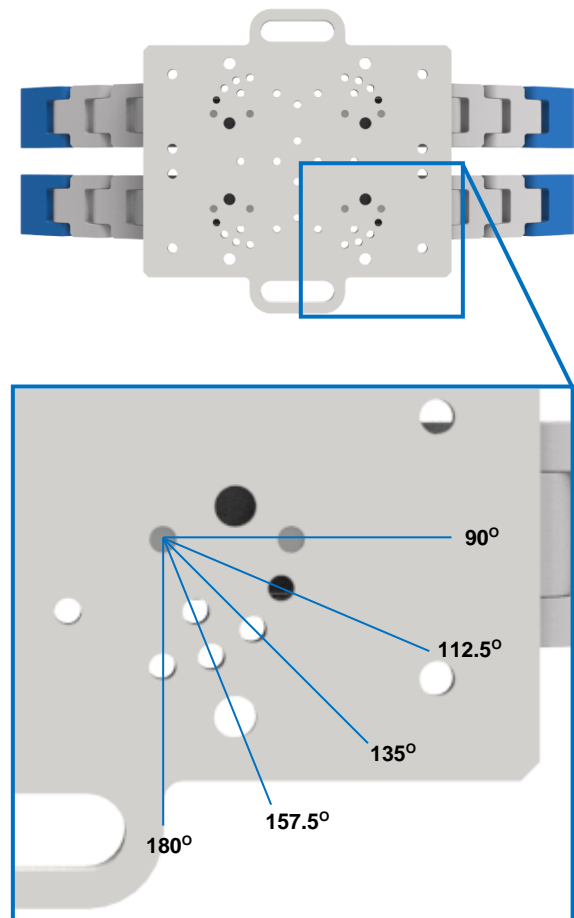

1. Position the 4 x Link Arms on the countersunk, rear face of the Bracket Plate to achieve the most suitable configuration.
2. Place an M5 spring washer (supplied) onto an M5 Button Head Socket Bolt (supplied).
3. Insert the bolt and spring washer into counterbored hole in the Mounting Link and screw to the Bracket Plate.
4. Repeat steps 2 and 3 until each Mounting Link and corresponding Link Arm has been fitted with two fixings.
5. Use a 3mm Hex Key (not supplied) to tighten the fixings and secure the Mounting Links to the Bracket Plate.
6. If desired, use countersunk fixings (not supplied) and medium strength thread lock (not supplied) to fix the Transmitter, Sensor and/or Battery to the matching BlokMag ®.

Installation

Pre-empt the position of the BlokMag ® and consider:

- a. the installation requirements of the mating Transmitter, Sensor and/or Battery;
 - b. the lanyard length and distance to a secure point.
1. Magnetically mount the BlokMag ® to a clean surface.
 2. Ensure the assembly and configuration of the link arms are suitable and adjust if necessary.
 3. Check each link arm is taught and correctly magnetised to the curved surface.
 4. Fit Rapid Link to BlokMag ®.
 5. Choke and secure a lanyard to fixed and secure point.
 6. Attach the loose end of lanyard to the Rapid Link.
 7. Firmly tighten the Rapid Link.
 8. Refer to the installation guide for the mating Transmitter, Sensor and/or Battery.

When necessary reverse the above steps for removal.

BlokCam Ltd
Unit 5 Sidings Court
Priory Park East
Hull
East Yorkshire
HU4 7DY
United Kingdom

+44 1482 351546
uk@blokcam.com

